

# JVC

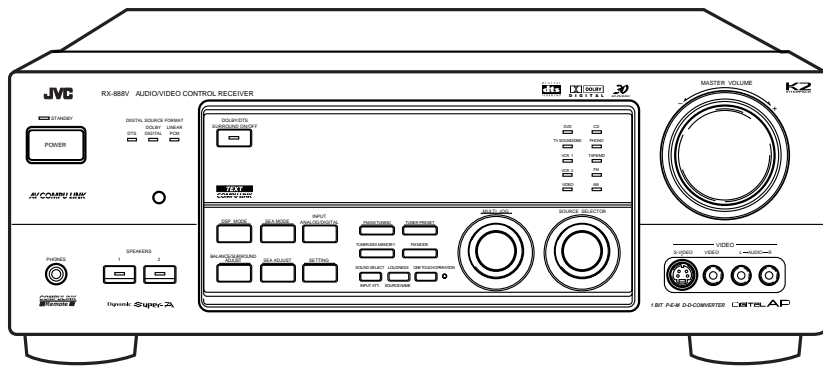

## AUDIO/VIDEO CONTROL RECEIVER

# RX-888VBK

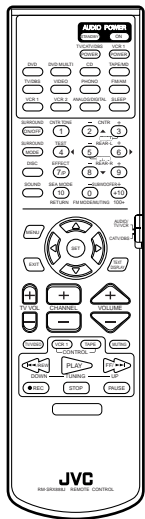

**K2**  
INTERFACE

**DIGITAL AP**

**Dynamic Super-A**

**TEXT**  
**COMPU LINK**

**AV COMPU LINK**

**COMPU LINK**  
**Remote**

**3D**  
3D-PHONIC

**DIGITAL**  
**dts**  
SURROUND

**DOLBY**  
**DIGITAL**

## INSTRUCTIONS

### For Customer Use:

Enter below the Model No. and Serial No. which are located either on the rear, bottom or side of the cabinet. Retain this information for future reference.

Model No. \_\_\_\_\_

Serial No. \_\_\_\_\_

LVT0175-001A

[J]

# Warnings, Cautions and Others

	<b>CAUTION</b> RISK OF ELECTRIC SHOCK DO NOT OPEN	
CAUTION: TO REDUCE THE RISK OF ELECTRIC SHOCK, DO NOT REMOVE COVER (OR BACK) NO USER SERVICEABLE PARTS INSIDE. REFER SERVICING TO QUALIFIED SERVICE PERSONNEL.		

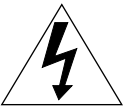

The lightning flash with arrowhead symbol, within an equilateral triangle is intended to alert the user to the presence of uninsulated "dangerous voltage" within the product's enclosure that may be of sufficient magnitude to constitute a risk of electric shock to persons.



The exclamation point within an equilateral triangle is intended to alert the user to the presence of important operating and maintenance (servicing) instructions in the literature accompanying the appliance.

**WARNING: TO REDUCE THE RISK OF FIRE OR ELECTRIC SHOCK, DO NOT EXPOSE THIS APPLIANCE TO RAIN OR MOISTURE.**

## CAUTION

To reduce the risk of electrical shocks, fire, etc.:

1. Do not remove screws, covers or cabinet.
2. Do not expose this appliance to rain or moisture.

**Caution — POWER switch!**  
Disconnect the mains plug to shut the power off completely. The POWER switch in any position does not disconnect the mains line. The power can be remote controlled.

**Caution — SPEAKER LOAD SELECTOR switch!**  
Match the position of SPEAKER LOAD SELECTOR switch on the back panel to the impedance of the speaker connected, to protect from overheating.

**For U.S.A.**  
This equipment has been tested and found to comply with the limits for a Class B digital device, pursuant to part 15 of the FCC Rules. These limits are designed to provide reasonable protection against harmful interference in a residential installation. This equipment generates, uses and can radiate radio frequency energy and, if not installed and used in accordance with the instructions, may cause harmful interference to radio communications. However, there is no guarantee that interference will not occur in a particular installation. If this equipment does cause harmful interference to radio or television reception, which can be determined by turning the equipment off and on, the user is encouraged to try to correct the interference by one or more of the following measures:  
Reorient or relocate the receiving antenna.  
Increase the separation between the equipment and receiver.  
Connect the equipment into an outlet on a circuit different from that to which the receiver is connected.  
Consult the dealer or an experienced radio/TV technician for help.

### Caution: Proper Ventilation

To avoid risk of electric shock and fire and to protect from damage.

Locate the apparatus as follows:

- Front: No obstructions open spacing.
- Sides: No obstructions in 10 cm from the sides.
- Top: No obstructions in 10 cm from the top.
- Back: No obstructions in 15 cm from the back
- Bottom: No obstructions, place on the level surface.

In addition, maintain the best possible air circulation as illustrated.

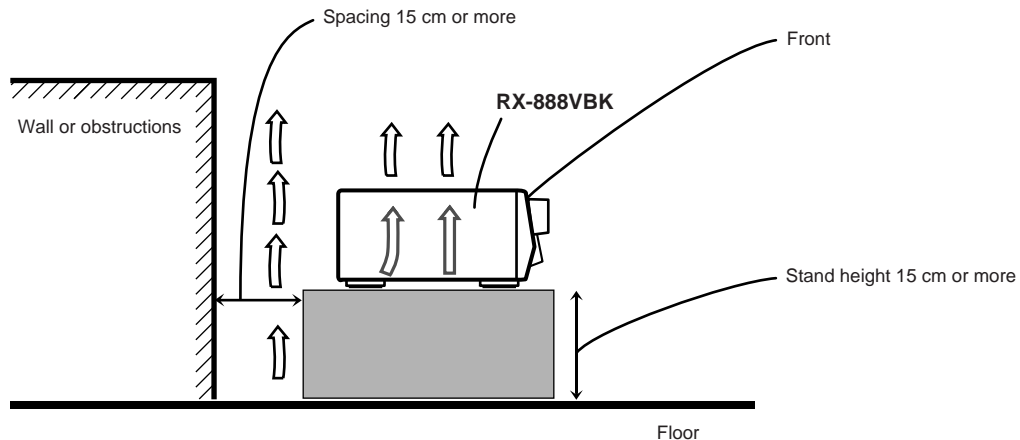

<b>Parts Identification .....</b>	<b>2</b>	<b>Using the DSP Modes .....</b>	<b>20</b>
<b>Getting Started .....</b>	<b>3</b>	Available DSP Modes According to the Speaker Arrangement ..	22
Before Installation .....	3	Adjusting the 3D-PHONIC Modes .....	23
Checking the Supplied Accessories .....	3	Adjusting the DAP Modes .....	23
Connecting the FM and AM Antennas .....	3	Adjusting the Surround Modes .....	24
Connecting the Speakers .....	4	Activating the DSP Modes .....	27
Connecting Audio/Video Components .....	5	<b>Using the DVD MULTI Playback Mode .....</b>	<b>29</b>
Connecting the Power Cord .....	8	Activating the DVD MULTI Playback Mode .....	29
Putting Batteries in the Remote Control .....	8	<b>Using the On-Screen Menus .....</b>	<b>31</b>
<b>Basic Operations .....</b>	<b>9</b>	Selecting the Source to Play .....	31
Turning the Power On and Off (Standby) .....	9	Selecting Different Sources for Picture and Sound .....	31
Selecting the Source to Play .....	9	Activating the DSP Modes .....	31
Adjusting the Volume .....	10	Adjusting the Front Speaker Output Balance .....	31
Selecting the Front Speakers .....	10	Listening at Low Volume (Loudness) .....	32
Muting the Sound .....	11	Attenuating the Input Signal .....	32
Listening at Low Volume (Loudness) .....	11	Adjusting the Subwoofer Output Level .....	32
Attenuating the Input Signal .....	11	Adjusting the DSP Modes .....	32
Adjusting the Subwoofer Output Level .....	11	Activating the DVD MULTI Playback Mode .....	33
<b>Basic Settings .....</b>	<b>12</b>	Selecting Your Favorite SEA Mode .....	33
Recording a Source .....	12	Creating Your Own SEA Mode .....	33
Adjusting the Front Speaker Output Balance .....	12	Setting the Basic Setting Items .....	34
Changing the Source Name .....	12	Operating the Tuner .....	34
Setting the Subwoofer Information .....	12	Storing the Preset Stations .....	35
Digital Input (DIGITAL IN) Terminal Setting .....	13	Assigning Names to Preset Stations .....	35
Selecting the Analog or Digital Input Mode .....	13	<b>COMPU LINK Remote Control System .....</b>	<b>36</b>
Showing the Text Information on the Display .....	13	<b>TEXT COMPU LINK Remote Control System ..</b>	<b>37</b>
Setting the Speakers for the DSP Modes .....	14	Showing the Disc Information on the TV Screen .....	38
Storing the Basic Settings and Adjustments — One Touch		Searching for a Disc (Only for the CD player) .....	39
Operation .....	16	Entering the Disc Information .....	40
Using the Sleep Timer .....	16	<b>AV COMPU LINK Remote Control System ...</b>	<b>42</b>
<b>Receiving Radio Broadcasts .....</b>	<b>17</b>	<b>Operating JVC's Audio/Video Components ...</b>	<b>44</b>
Tuning in Stations Manually .....	17	<b>Operating Other Manufacturers' Video</b>	
Using Preset Tuning .....	17	<b>Equipment .....</b>	<b>46</b>
Selecting the FM Reception Mode .....	18	<b>Troubleshooting .....</b>	<b>52</b>
Assigning Names to Preset Stations .....	18	<b>Specifications .....</b>	<b>53</b>
<b>Using the SEA Modes .....</b>	<b>19</b>		
Selecting Your Favorite SEA Mode .....	19		
Creating Your Own SEA Mode .....	19		

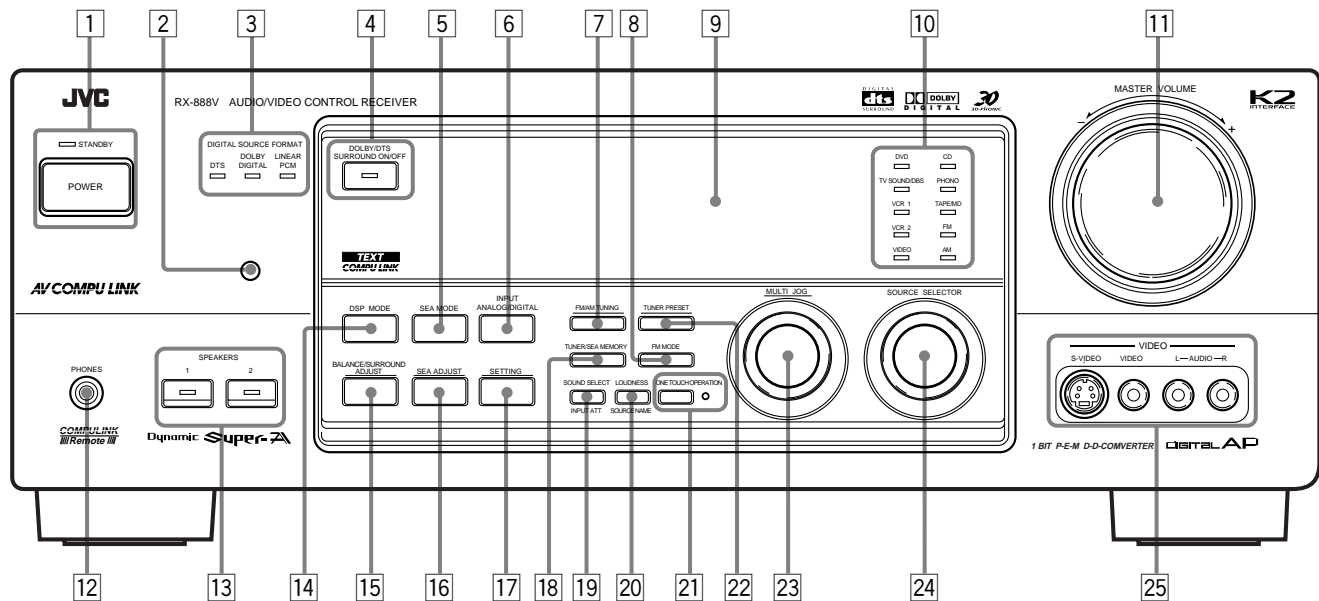

### Front Panel

- 1 POWER button and STANDBY lamp (9)
- 2 Remote sensor (8)
- 3 DIGITAL SOURCE FORMAT lamps (10)  
DTS, DOLBY DIGITAL, LINEAR PCM
- 4 DOLBY/DTS SURROUND ON/OFF button and lamp (27)
- 5 SEA MODE button (19)
- 6 INPUT ANALOG/DIGITAL button (13)
- 7 FM/AM TUNING button (17) \*
- 8 FM MODE button (18)
- 9 Display (9)
- 10 Source lamps (9)
- 11 MASTER VOLUME control (10)
- 12 PHONES jack (11)
- 13 SPEAKERS 1/2 buttons and lamps (10)
- 14 DSP MODE button (23)
- 15 BALANCE/SURROUND ADJUST button (11, 12, 23) \*
- 16 SEA ADJUST button (19) \*
- 17 SETTING button (13 – 15) \*
- 18 TUNER/SEA MEMORY button (17 – 19)
- 19 SOUND SELECT/INPUT ATT button (10, 11)
- 20 LOUDNESS/SOURCE NAME button (11, 12)
- 21 ONE TOUCH OPERATION button and lamp (16)
- 22 TUNER PRESET button (18) \*
- 23 MULTI JOG control

What this control actually does depends on which function you are trying to adjust. Before using this control, select the function by pressing one of the buttons marked with \*.

- 24 SOURCE SELECTOR control (9)
- 25 VIDEO input jacks (7)

### Remote Control

- 1 TV/CATV/DBS POWER button (45 – 47)
- 2 Source selecting buttons (9)  
DVD, DVD MULTI, CD, TAPE/MD, TV/DBS, VIDEO, PHONO, FM/AM, VCR 1, VCR 2
- 3 SURROUND ON/OFF button (27)
- 4 SURROUND MODE button (23)
- 5 DISC button (44)
- 6 SOUND button (19, 23)
- 7 On-screen operation buttons (31, 38)  
MENU, SET, EXIT, Δ, ▽, ◀, ▶
- 8 TV VOL +/- buttons (45, 46)
- 9 Operating buttons for audio/video components (44 – 47)
- 10 AUDIO POWER buttons (9)  
STANDBY, ON
- 11 VCR 1 POWER button (45, 47)
- 12 SLEEP button (16)
- 13 ANALOG/DIGITAL button (13)
- 14
  - 10 keys for selecting preset channel (18)
  - 10 keys for adjusting sound (23 – 26, 30)
  - 10 keys for operating audio/video components (44 – 47)
- 15 Remote control mode selector (9, 44, 46)
- 16 TEXT DISPLAY button (38)
- 17 CHANNEL +/- button (45 – 47)
- 18 VOLUME +/- button (10)
- 19 MUTING button (11)

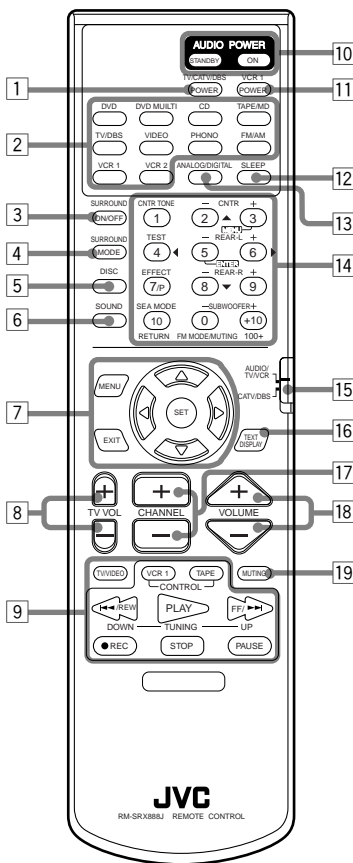

## Before Installation

### General

- Be sure your hands are dry.
- Turn the power off to all components.
- Read the manuals supplied with the components you are going to connect.

### Locations

- Install the receiver in a location that is level and protected from moisture.
- The temperature around the receiver must be between  $-5^{\circ}$  and  $35^{\circ}$  C ( $23^{\circ}$  and  $95^{\circ}$  F).
- Make sure there is good ventilation around the receiver. Poor ventilation could cause overheating and damage the receiver.

### Handling the receiver

- Do not insert any metal object into the receiver.
- Do not disassemble the receiver or remove screws, covers, or cabinet.
- Do not expose the receiver to rain or moisture.

## Checking the Supplied Accessories

Check to be sure you have all of the following items, which are supplied with the receiver.

The number in the parentheses indicates quantity of the pieces supplied.

- **Remote Control (1)**
- **Batteries (2)**
- **AM Loop Antenna (1)**
- **FM Antenna (1)**

If anything is missing, contact your dealer immediately.

## Connecting the FM and AM Antennas

### FM Antenna Connections

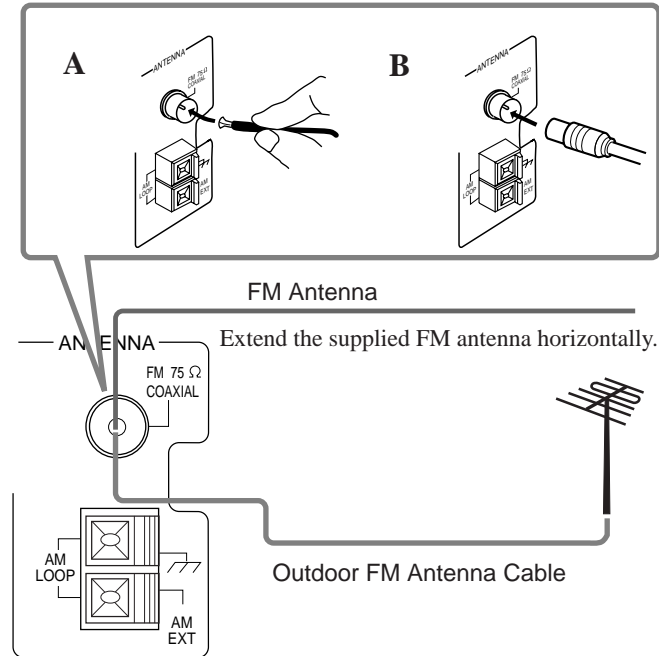

#### A. Using the Supplied FM Antenna

The FM antenna provided can be connected to the FM 75 $\Omega$  COAXIAL terminal as temporary measure.

#### B. Using the Standard Type Connector (Not Supplied)

A standard type connector should be connected to the FM 75 $\Omega$  COAXIAL terminal.

#### Note:

*If reception is poor, connect the outdoor antenna.*

*Before attaching a 75 $\Omega$  coaxial cable (the kind with a round wire going to an outdoor antenna), disconnect the supplied FM antenna.*

# AM Antenna Connections

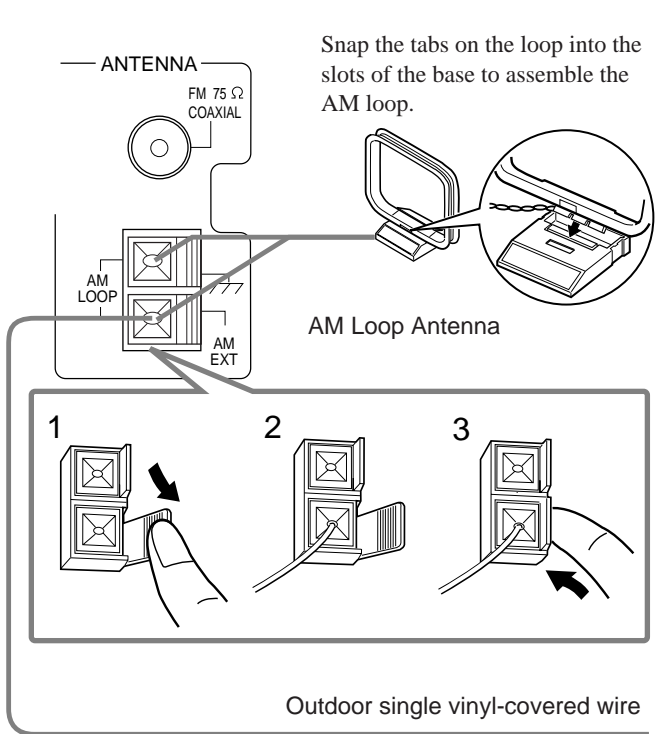

Turn the loop until you have the best reception.

**Notes:**

- Make sure the antenna conductors do not touch any other terminals, connecting cords and power cord. This could cause poor reception.
- If reception is poor, connect an outdoor single vinyl-covered wire to the AM EXT terminal. (Keep the AM loop antenna connected.)

## Connecting the Speakers

- You can connect the following speakers:
- Two pairs of front speakers to produce normal stereo sound.
  - One pair of rear speakers to enjoy the surround effect.
  - One center speaker to produce more effective surround effect (to emphasize human voices).
  - One subwoofer to enhance the bass.

**IMPORTANT:**  
After connecting the speakers listed above, set the speaker setting information properly to obtain the best possible DSP effect. For details, see page 14.

For each speaker (except for a subwoofer), connect the (-) and (+) terminals on the rear panel to the (-) and (+) terminals marked on the speakers. For connecting a subwoofer, see page 5.

**CAUTION:**  
Use speakers with the SPEAKER IMPEDANCE indicated by the speaker terminals.

# Basic connecting procedure

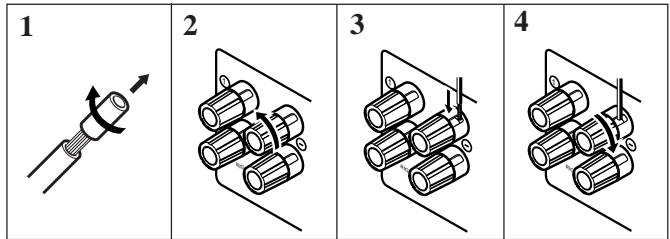

- 1 Cut, twist and remove the insulation at the end of each speaker signal cable (not supplied).
- 2 Turn the knob counterclockwise.
- 3 Insert the speaker signal cable.
- 4 Turn the knob clockwise.

## Connecting the front speakers

You can connect two pairs of front speakers (one pair to the FRONT SPEAKERS ① terminals, and another pair to the FRONT SPEAKERS ② terminals).

Right speaker — FRONT SPEAKERS ① — Left speaker

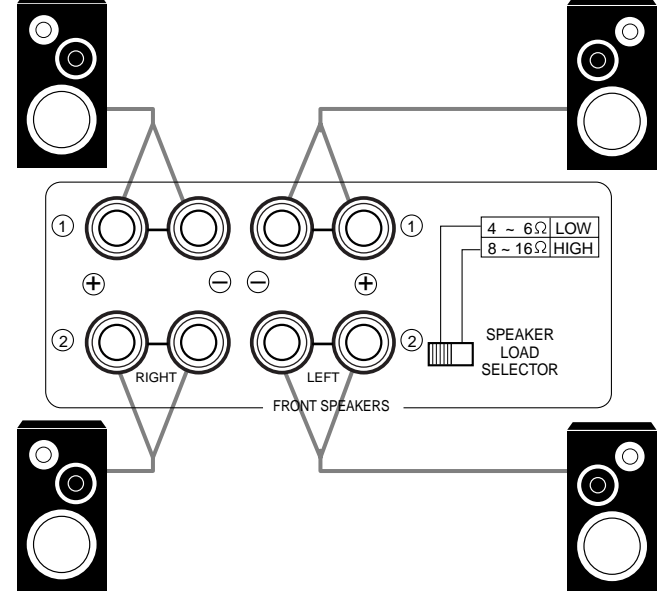

**IMPORTANT:**  
To obtain the best possible output power from the receiver, and to prevent the receiver from being overheated, the receiver has the SPEAKER LOAD SELECTOR which has to be set as follows:

- Set it to the HIGH position when the impedance of the front speakers connected is within the range of 8 ohms to 16 ohms.
- Set it to the LOW position when the impedance of the front speakers connected is within the range of 4 ohms to 6 ohms.

### Connecting the rear and center speakers

Connect rear speakers to the REAR SPEAKERS terminals and a center speaker to the CENTER SPEAKER terminals.

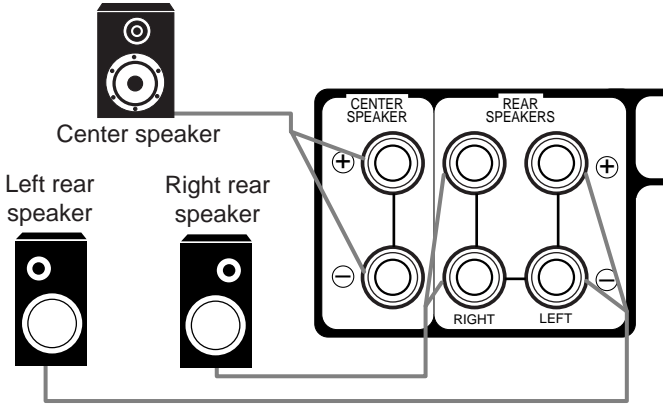

### Connecting the subwoofer speaker

You can enhance the bass by connecting a subwoofer. Connect the input jack of a powered subwoofer to the SUBWOOFER OUT jack on the rear panel, using a cable with RCA pin plugs (not supplied).



Powered subwoofer

## Connecting Audio/Video Components

You can connect the following audio/video components to this receiver. Refer also to the manuals supplied with your components.

Audio Components	Video Components
• Turntable	• DVD player*
• CD player*	• TV
• Cassette deck or MD recorder*	• DBS tuner*
	• VCRs
_____	• Video camera

\* You can connect these components using the methods described in "Analog connections" (to the right) or in "Digital connections" (see page 8).

### Analog connections

#### Audio component connections

Use the cables with RCA pin plugs (not supplied). Connect the white plug to the audio left jack, and the red plug to the audio right jack.

#### CAUTION:

If you connect a sound-enhancing device such as a graphic equalizer between the source components and this receiver, the sound output through this receiver may be distorted.

#### Turntable

If an earth cable is provided for your turntable, connect the cable to the screw marked (⏏) on the rear panel.

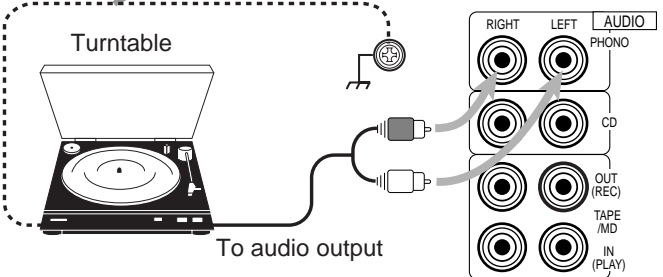

#### Note:

Any turntables incorporating a small-output cartridge such as an MC (moving-coil type) must be connected to this receiver through a commercial head amplifier or step-up transformer. Direct connection may result in insufficient volume.

#### CD player

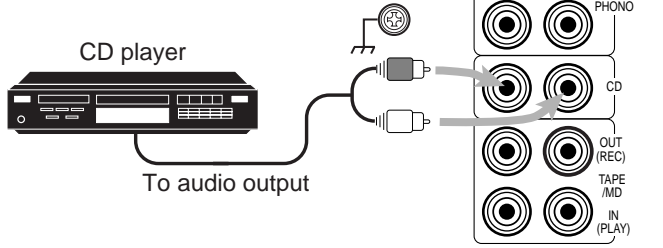

## Cassette deck or MD recorder

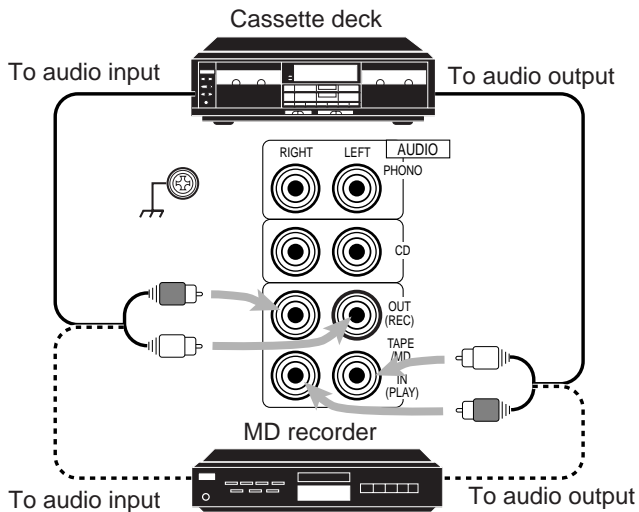

### Note:

You can connect either a cassette deck or an MD recorder to the TAPE/MD jacks. When connecting an MD recorder to the TAPE/MD jacks, change the source name, which will be shown on the display when selected as the source, to "MD." See page 12 for details.

### If your audio components have a COMPU LINK-3 or TEXT COMPU LINK terminal

- See also page 36 for detailed information about the connection and the COMPU LINK-3 remote control system.
- See also page 37 for detailed information about the connection and the TEXT COMPU LINK remote control system.

### Video component connections

Use the cables with RCA pin plugs (not supplied). Connect the white plug to the audio left jack, the red plug to the audio right jack, and the yellow plug to the video jack. If your video components have S-video (Y/C-separation) terminals, connect them using S-video cables (not supplied). Connecting these video components through the S-video input/output terminals will give you better picture playback (or recording) quality.

## IMPORTANT:

This receiver is equipped with both the composite video and S-video input/output terminals for connecting video components. You do not have to connect both the composite video and S-video terminals.

However, **remember that the video signals from the composite video input terminals are output only through the composite video output terminals, while the ones from the S-video input terminals are output only through the S-video output terminals.** Therefore, if a recording video component and a playing video component are connected to the receiver through the different video terminals, you cannot record the picture from the playing component on the recording component. In addition, if the TV and a playing video component are connected to the receiver through the different video terminals, you cannot view the playback picture from the playing component on the TV.

**To view and record the playback picture from the video component connected to the VCR 2 jacks, you must connect the TV and the recording video component through the composite video terminals.**

## VCR

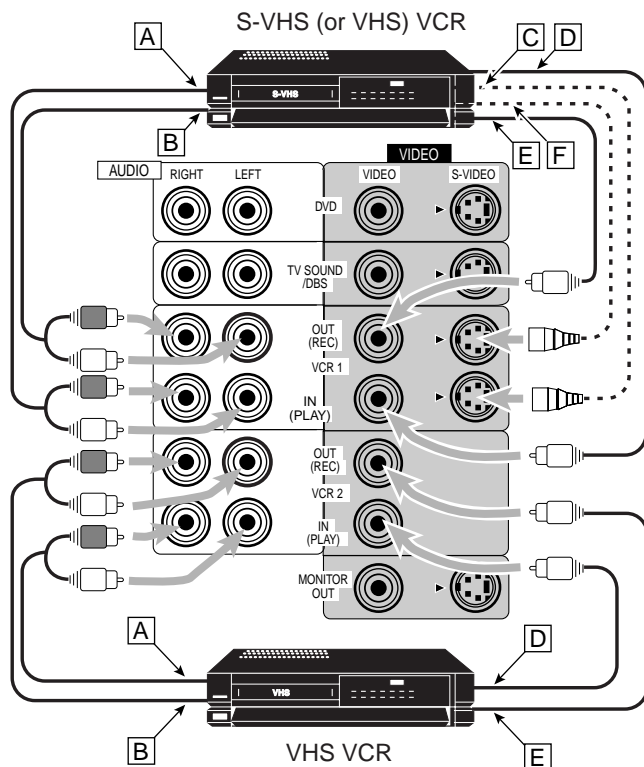

- A To left/right channel audio output
- B To left/right channel audio input
- C To S-video output
- D To composite video output
- E To composite video input
- F To S-video input



### Video camera

The VIDEO jacks on the front panel is convenient when connecting and disconnecting the equipment frequently.

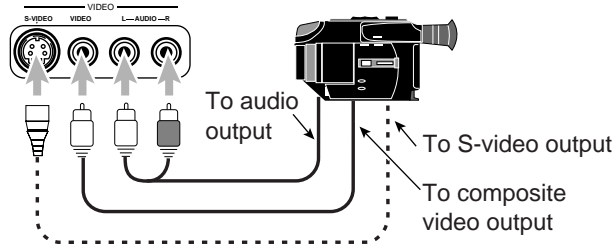

### TV and/or DBS tuner

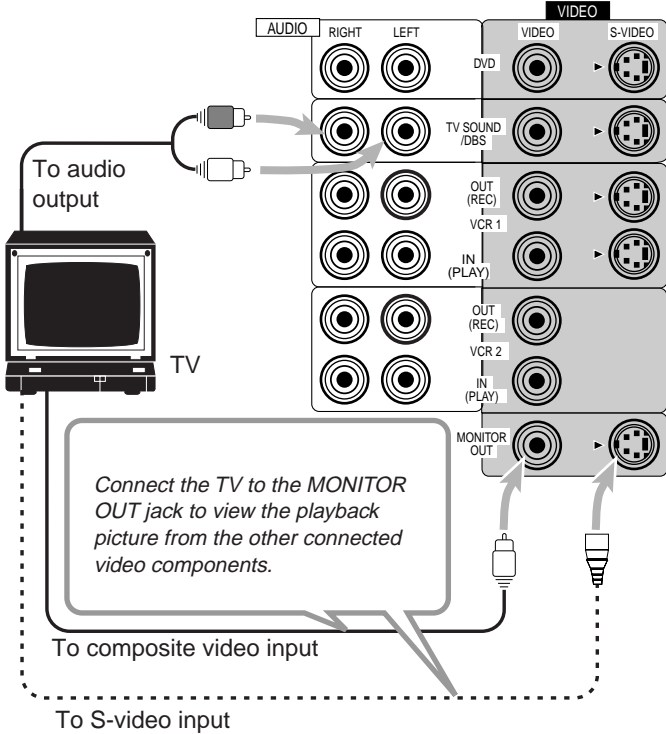

**Note:**  
When connecting the TV to the TV SOUND/DBS jacks, DO NOT connect the TV's video output to these video input terminals.

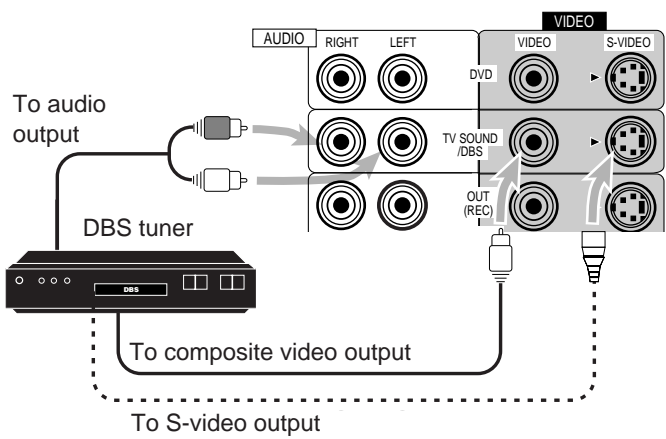

**Note:**  
When connecting the DBS tuner to the TV SOUND/DBS jacks

### DVD player

• When you connect the DVD player with stereo output jacks:

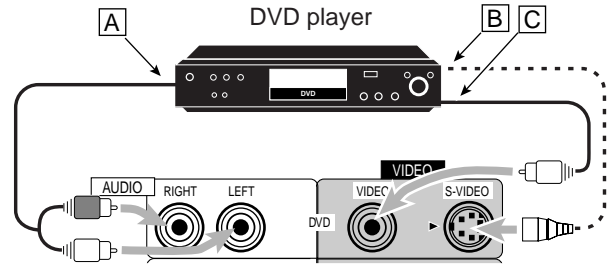

- A To front left/right channel audio output (or to audio mixed output if necessary)
- B To S-video output
- C To composite video output

• When you connect the DVD player with its analog discrete output (5.1 CH reproduction) jacks:

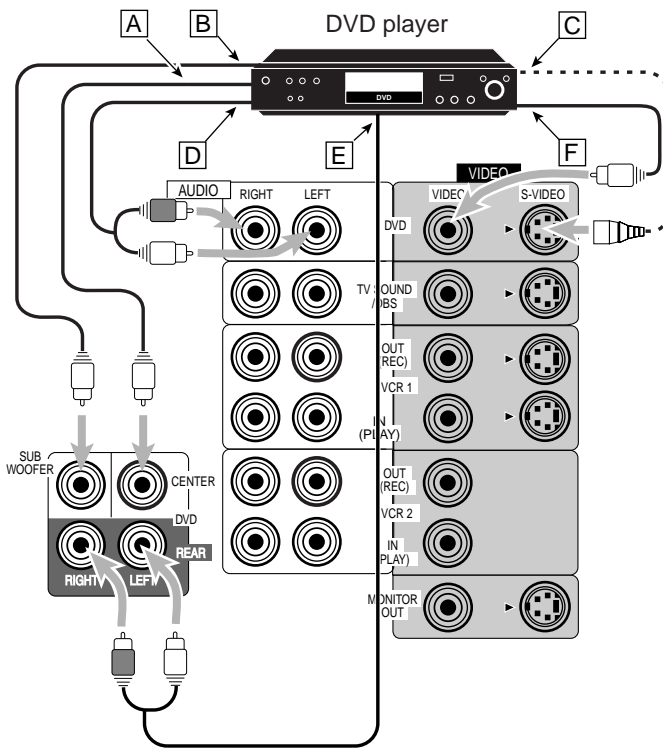

- A To center channel audio output
- B To subwoofer audio output
- C To S-video output
- D To front left/right channel audio output
- E To rear left/right channel audio output
- F To composite video output

## Digital connections

This receiver is equipped with three DIGITAL IN terminals — one digital coaxial terminal and two digital optical terminals.

You can connect any component to any one of the digital terminals using the digital coaxial cable (not supplied) or digital optical cable (not supplied).

### IMPORTANT:

- When connecting the DVD player or the DBS tuner using the digital terminal, you also need to connect it to the video jack (either composite video terminal or S-video terminal) on the rear. Without connecting it to the video jack, you can view no playback picture.
- After connecting the components using the DIGITAL IN terminals, set the following correctly if necessary.
  - Select the digital input mode correctly. For details, see "Selecting the Analog or Digital Input Mode" on page 13.
  - Set the digital input (DIGITAL IN) terminal setting correctly. For details, see "Digital Input (DIGITAL IN) Terminal Setting" on page 13.

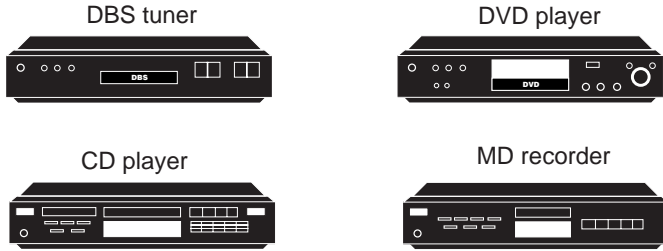

When the component has a digital coaxial output terminal, connect it to the DIGITAL 1 (DBS) terminal, using the digital coaxial cable (not supplied).

When the component has a digital optical output terminal, connect it to the DIGITAL 2 (DVD) or DIGITAL 3 (CD) terminal, using the digital optical cable (not supplied).

Before connecting a digital optical cable, unplug the protective plug.

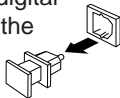

## Connecting the Power Cord

Before plugging the receiver into an AC outlet, make sure that all connections have been made.

### Plug the power cord into an AC outlet.

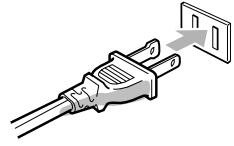

Keep the power cord away from the connecting cables and the antenna. The power cord may cause noise or screen interference. We recommend that you use a coaxial cable to connect the antenna, since it is well-shielded against interference.

### Note:

The preset settings such as preset channel and sound adjustment may be erased in a few days in the following cases:

- When you unplug the power cord.
- When a power failure occurs.

### CAUTIONS:

- Do not touch the power cord with wet hands.
- Do not pull on the power cord to unplug the cord. When unplugging the cord, always grasp the plug so as not to damage the cord.

## Putting Batteries in the Remote Control

Before using the remote control, put two supplied batteries first. When using the remote control, aim the remote control directly at the remote sensor on the receiver.

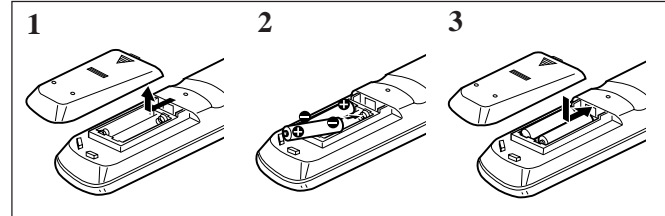

- On the back of the remote control, remove the battery cover.
- Insert batteries. Make sure to match the polarity: (+) to (+).
- Replace the cover.

If the range or effectiveness of the remote control decreases, replace the batteries. Use two R6P(SUM-3)/AA(15F) type dry-cell batteries.

### CAUTION:

Follow these precautions to avoid leaking or cracking cells:

- Place batteries in the remote control so they match the polarity: (+) to (+).
- Use the correct type of batteries. Batteries that look similar may differ in voltage.
- Always replace both batteries at the same time.
- Do not expose batteries to heat or flame.

### Notes:

- When shipped from the factory, the DIGITAL IN terminals has been set for use with the following components.
  - DIGITAL 1 (coaxial): For DBS tuner
  - DIGITAL 2 (optical): For DVD player
  - DIGITAL 3 (optical): For CD player
- When you want to operate the CD player or MD recorder using the COMPU LINK remote control system, connect the target component also as described in "Analog connections" (see pages 5 and 6).
- When you want to operate the DVD player using the AV COMPU LINK remote control system, connect the DVD player also as

## IMPORTANT:

When using the remote control, check to see if its remote control mode selector is set to the correct position:

**To operate an audio system, TV, and VCR,** set it to "AUDIO/TV/VCR."

**To operate a CATV converter and DBS tuner,** set it to "CATV/DBS."

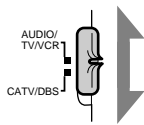

## From the remote control:

Press one of the source selecting buttons.

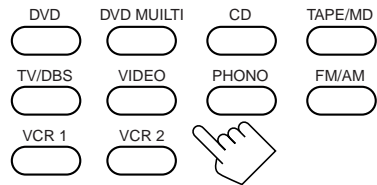

## Turning the Power On and Off (Standby)

### On the front panel:

**To turn on the power,** press POWER.

The STANDBY lamp goes off. The name of the current source (or station frequency) appears on the display.

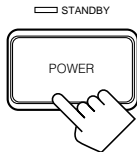

Current source name appears

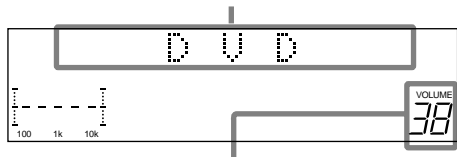

Current volume level is shown here

**To turn off the power (into standby mode),** press POWER again.

The STANDBY lamp lights up. A small amount of power is consumed in standby mode. To turn the power off completely, unplug the AC power cord.

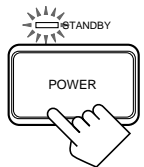

### From the remote control:

**To turn on the power,** press AUDIO POWER ON.

The STANDBY lamp goes off. The name of the current source (or station frequency) appears on the display.

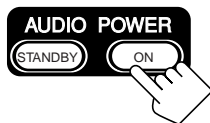

**To turn off the power (into standby mode),** press AUDIO POWER STANDBY.

The STANDBY lamp lights up.



## Selecting the Source to Play

### On the front panel:

Turn SOURCE SELECTOR until the source name you want appears on the display.

- As you turn the selector, the source changes as follows:

CD ⇄ PHONO ⇄ TAPE (or MD) ⇄ FM ⇄ AM ⇄ DVD ⇄ DVD MULTI ⇄ TV SOUND (or DBS) ⇄ VCR 1 ⇄ VCR 2 ⇄ VIDEO ⇄ (back to the beginning)

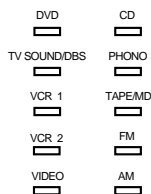
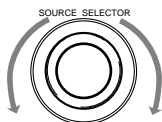

The selected source lamp also lights up.

- The DVD lamp lights up both for "DVD" and "DVD MULTI."

Selected source name appears

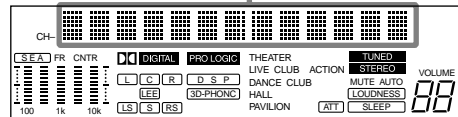

DVD

Select the DVD player.

DVD MULTI

Select the DVD player for viewing the digital video disc using the analog discrete output mode (5.1CH reproduction) on the DVD player.

To enjoy the DVD MULTI playback, see page 29.

CD \*

Select the CD player.

TAPE/MD \*

Select the cassette deck (or the MD recorder).

TV/DBS

- Select TV sounds when the remote control mode selector is set to "AUDIO/TV/VCR."

- Select the DBS tuner when the remote control mode selector is set to "CATV/DBS."

VIDEO

Select video component connected to the VIDEO jacks.

PHONO \*

Select the turntable.

FM/AM \*

Select an FM or AM broadcast.

- Each time you press the button, the band alternates between FM and AM.

VCR 1

Select the video component connected to the VCR 1 jacks.

VCR 2

Select the video component connected to the VCR 2 jacks.

### Notes:

- When connecting an MD recorder (to the TAPE/MD jacks), and a DBS tuner (to the TV SOUND/DBS jacks), change the source name shown on the display. For details, see page 12.
- When you press one of the source selecting buttons on the remote control marked above with an asterisk (\*), the receiver automatically turns on.

## **When playing a digital source through a digital terminal**

- The DIGITAL SOURCE FORMAT lamps on the front panel indicate what type of the digital signal comes into the receiver.

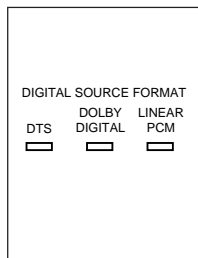

### **DTS:**

Lights up when DTS Digital Surround signals (see page 21) come in.

### **DOLBY DIGITAL:**

Lights up when Dolby Digital signals (see page 21) come in.

### **LINEAR PCM:**

Lights up when Linear PCM signals come in.

- The signal indicators also light up on the display to indicate the incoming channel signals. (Only the indicators for the incoming signals light up.)

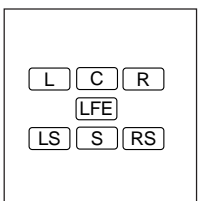

L: Left front channel

R: Right front channel

C: Center channel

LS: Left rear channel

RS: Right rear channel

S: Rear channel (monaural)

LFE: Subwoofer channel

## **Selecting different sources for picture and sound**

You can watch picture from a video component while listening to sound from another component.

### **On the front panel:**

1. Press **SOUND SELECT (INPUT ATT)** briefly while viewing the picture from a video component such as the VCR or DVD player, etc.

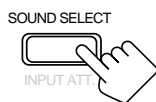

“SOUND SELECT” appears on the display.

2. Turn **SOURCE SELECTOR** to select the sound (except the TV sound), while the indication of the above step is still on the display.

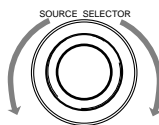

### **From the remote control:**

Press one of the audio source selecting buttons (CD, TAPE/MD, PHONO, FM/AM), while viewing the picture from a video component such as the VCR or DVD player, etc.

### **Notes:**

- Once you have selected a video source, pictures of the selected source are sent to the TV until you select another video source.
- When you select “TV SOUND” as the source, this function does not work.

## **Adjusting the Volume**

### **On the front panel:**

**To increase the volume**, turn MASTER VOLUME clockwise.

**To decrease the volume**, turn it counterclockwise.

- When you turn MASTER VOLUME rapidly, the volume level also changes rapidly.
- When you turn MASTER VOLUME slowly, the volume level also changes slowly.

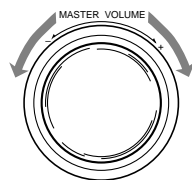

### **From the remote control:**

**To increase the volume**, press VOLUME +.

**To decrease the volume**, press VOLUME -.



### **CAUTION:**

Always set the volume to the minimum before starting any source. If the volume is set at its high level, the sudden blast of sound energy can permanently damage your hearing and/or ruin your speakers.

### **Note:**

The volume level can be adjusted within the range of “0” (minimum) to “90” (maximum).

## **Selecting the Front Speakers**

### **On the front panel ONLY:**

When you have connected two pairs of the front speakers, you can select which to use.

Press **SPEAKERS 1** or **SPEAKERS 2** to select the speaker to use.

- Each time you press the button, the lamp on the respective button turns on and off. When the lamp on either button lights up, the respective speakers are activated.

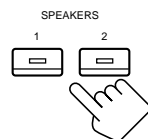

### **IMPORTANT:**

You can activate two pairs of the front speakers at the same time only when the SPEAKER LOAD SELECTOR on the rear panel is set to “HIGH” and when no signals are sent to the center and rear speakers. Otherwise, activating one pair of the speakers deactivates the other.

### **Note:**

If you use any of the DSP modes other than the 3D-PHONIC modes with both front speakers activated, the speakers connected to the FRONT SPEAKERS ② terminals are deactivated.

## Listening only with headphones

1. Connect a pair of headphones to the PHONES jack on the front panel.
2. Press SPEAKERS 1 and/or 2 so that no lamps on the buttons are turned on.

### CAUTION:

Be sure to turn down the volume before connecting or putting on headphones, as high volume can damage both the headphones and your hearing.

## Muting the Sound

### From the remote control ONLY:

Press **MUTING** to mute the sound through all speakers and headphones connected.

“MUTING” appears on the display and the volume turns off (the volume level indicator goes off).



To restore the sound, press **MUTING** again so that “OFF” appears on the display.

- Turning **MASTER VOLUME** on the front panel or pressing **VOLUME +/-** on the remote control also restores the sound.

## Listening at Low Volume (Loudness)

Human ears are not sensitive to bass at low volume. To compensate for this, the loudness function automatically boosts the bass level as you lower the volume.

### On the front panel ONLY:

Press **LOUDNESS (SOURCE NAME)** briefly to select the loudness function.

- Each time you press the button, the loudness function turns on (“LOUDNESS ON”) and off (“LOUDNESS OFF”).
  - Select “LOUDNESS ON” to activate the loudness function. The **LOUDNESS** indicator lights up on the display.
  - Select “LOUDNESS OFF” to cancel it. The indicator goes off.



### Note:

The loudness function affects the front speaker sounds only.

## Attenuating the Input Signal

When the input level of the playing source is too high, the sounds will be distorted. If this happens, you need to attenuate the input signal level to prevent the sound distortion.

### On the front panel ONLY:

Press and hold **INPUT ATT (SOUND SELECT)** so that the **ATT** indicator lights up on the display.

- Each time you press and hold the button, the Input Attenuator mode turns on (“INPUT ATT ON”) or off (“INPUT NORMAL”).

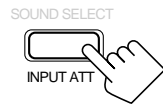

### Notes:

- This function is available only for the sources connected using the analog terminals.
- This function takes effect when the DSP mode is in use.
- When selecting “DVD MULTI” as the source, this effect does not work.

## Adjusting the Subwoofer Output Level

You can adjust the subwoofer output level if you have selected “YES” for the “SUBWOOFER” (see page 12).

Once it has been adjusted, the receiver memorizes the adjustment.

### Before you start, remember....

- There is a time limit in doing the following steps. If the setting is canceled before you finish, start from step 1 again.

### On the front panel:

1. Press **BALANCE/SURROUND ADJUST** repeatedly until “SUBWFR LEVEL” appears on the display.

The display changes to show the current setting.

2. Turn **MULTI JOG** to adjust the subwoofer output level (–10 dB to +10 dB).

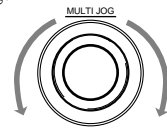

### From the remote control:

1. Press **SOUND**.  
The 10 keys are activated for sound adjustments.
2. Press **SUBWOOFER +/-** to adjust the subwoofer output level (–10 dB to +10 dB).

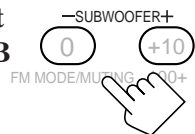
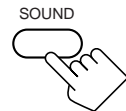

Some of the following settings are required after connecting and operating your listening room, and others will make operations easier.

## IMPORTANT:

When using the remote control, check to see if its remote control mode selector is set to the correct position:

**To operate this receiver**, set it to “AUDIO/TV/VCR” (except when selecting the DBS tuner as the source).

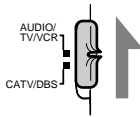

## Recording a Source

You can record any source playing through the receiver to a cassette deck (or an MD recorder) connected to the TAPE/MD jacks and the VCRs connected to the VCR 1 and VCR 2 jacks at the same time.

While recording, you can adjust the volume level, without affecting the sound levels of the recording.

## IMPORTANT:

- Before recording a digital source, turn off the DSP mode (see page 20).
- While recording a digital source, do not change the SEA mode (see page 19) or DSP mode (see page 20); otherwise, recording will be interrupted.

### Note:

The SEA modes and DSP modes cannot affect the recording while recording an analog source.

## Adjusting the Front Speaker Output Balance

If the sounds you hear from the front right and left speakers are unequal, you can adjust the speaker output balance.

### Before you start, remember....

- There is a time limit in doing the following steps. If the setting is canceled before you finish, start from step 1 again.

### On the front panel ONLY:

1. Press **BALANCE/SURROUND ADJUST** repeatedly until “L/R BALANCE” appears on the display.



The display changes to show the current setting.

2. Turn **MULTI JOG** to adjust the balance.

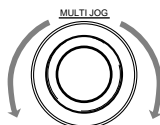

- Turning it clockwise decreases the left channel output.
- Turning it counterclockwise decreases the right channel output.

## Changing the Source Name

When you have connected an MD recorder to the TAPE/MD jacks or the DBS tuner to the TV SOUND/DBS jacks on the rear panel, change the source name shown on the display when you select the MD recorder or DBS tuner as the source.

### On the front panel ONLY:

1. When changing the source name from “TAPE” to “MD”:

- Turn **SOURCE SELECTOR** until “TAPE” appears.

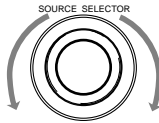

When changing the source name from “TV SOUND” to “DBS”:

- Turn **SOURCE SELECTOR** until “TV SOUND” appears.

2. Press and hold **SOURCE NAME (LOUDNESS)** until “ASSGN. MD” or “ASSGN. DBS” appears on the display.



To change the source name to “TAPE” or “TV SOUND,” repeat the same procedure above — in step 1, select “MD” or “DBS” then press and hold SOURCE NAME (LOUDNESS).

### Note:

Without changing the source name, you can still use the connected components. However, there may be some inconvenience.

- “TAPE” or “TV SOUND” will appear on the display when you select the MD recorder or DBS tuner.
- You cannot use the digital input (see page 13) for the MD recorder and the DBS tuner.
- You cannot use the COMPU LINK remote control system (see page 36) to operate the MD recorder.

## Setting the Subwoofer Information

Register whether or not you have connected a subwoofer.

### Before you start, remember....

- There is a time limit in doing the following steps. If the setting is canceled before you finish, start from step 1 again.

### On the front panel ONLY:

1. Press **SETTING** repeatedly until “SUBWOOFER” appears on the display.

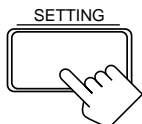

The display changes to show the current setting.

2. Turn **MULTI JOG** to register whether you have connected a subwoofer or not.

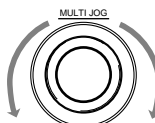

- As you turn it, the subwoofer setting alternates between “YES” or “NO.”

## Digital Input (DIGITAL IN) Terminal Setting

When you use the digital input terminals, you have to register what components are connected to which terminals (DIGITAL IN 1/2/3).

**Before you start, remember....**

- There is a time limit in doing the following steps. If the setting is canceled before you finish, start from step 1 again.

**On the front panel ONLY:**

1. Press **SETTING** repeatedly until “**DIGITAL IN**” appears on the display.

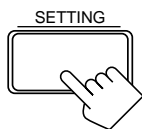

The display changes to show the current setting.

DIGITAL 2 terminal setting



2. Turn **MULTI JOG** to select the appropriate digital terminal setting.

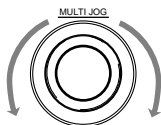

- As you turn it, the display changes to show the following:

1 DBS 2 DVD 3 CD	⇄	1 MD 2 DVD 3 CD	⇄
1 MD 2 DBS 3 CD	⇄	1 MD 2 DBS 3 DVD	⇄
1 CD 2 DVD 3 MD	⇄	1 CD 2 DBS 3 MD	⇄
1 CD 2 DBS 3 DVD	⇄	1 DVD 2 CD 3 MD	⇄
1 DVD 2 DBS 3 MD	⇄	1 DVD 2 DBS 3 CD	⇄
1 DBS 2 CD 3 MD	⇄	1 DBS 2 DVD 3 MD	⇄

(back to the beginning)

**Note:**

When shipped from the factory, the **DIGITAL IN** terminals can be used as the digital input for the following components.

- **DIGITAL 1** (coaxial): For DBS tuner
- **DIGITAL 2** (optical): For DVD player
- **DIGITAL 3** (optical): For CD player

## Selecting the Analog or Digital Input Mode

When you have connected some components such as CD player, MD recorder, DVD player and the DBS tuner using digital terminals (see page 8), you need to change the input mode for these components to the digital input.

**On the front panel:**

1. Turn **SOURCE SELECTOR** until the source (CD, MD, DBS, or DVD) for which you want to change the input mode from analog input to digital input appears on the display.

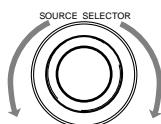

2. Press **INPUT ANALOG/DIGITAL** to change the input mode.

- Each time you press the button, the input mode alternates between the digital input and analog input.

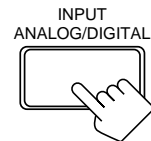

**From the remote control:**

1. Press the source selecting button (CD, TAPE/MD, TV/DBS\*, or DVD) for which you want to change the input mode from analog input to digital input.



2. Press **ANALOG/DIGITAL** to change the input mode.

- Each time you press the button, the input mode alternates between the digital input and analog input.



**Notes:**

- \* Before pressing TV/DBS, make sure that the remote control mode selector on the remote control is set to “CATV/DBS.”
- Once you have set the digital input for these components, it is always used every time you select these components as the source.

## Showing the Text Information on the Display

When you have connected an MD recorder or CD player equipped with TEXT COMPU LINK remote control system (see page 37), you can show the text information, such as disc title or track title, on the display of this receiver. To show it on the display, follow the procedure below.

**Before you start, remember....**

- There is a time limit in doing the following steps. If the setting is canceled before you finish, start from step 1 again.

**On the front panel ONLY:**

1. Press **SETTING** repeatedly until “**FL DISPLAY**” appears on the display.

The display changes to show the current setting.

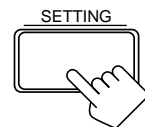

2. Turn **MULTI JOG** to select either the source name or the text information to be shown on the display.

- As you turn it, the display changes to show the following:

NORMAL ←→ TEXT

**NORMAL:** Source name appears during play.

**TEXT:** Text information appears during play.

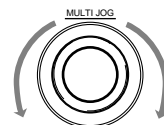

**Notes:**

- Though you have selected “TEXT,” the source name such as “CD” or “MD” appears if a playing disc has no text information.
- Though you have selected “NORMAL,” the setting is changed to “TEXT” in the following cases:

## Setting the Speakers for the DSP Modes

To obtain the best possible surround sound of the DSP modes, you have to register the information about the speakers arrangement after all connections are completed.

### Before you start, remember....

- There is a time limit in doing the following steps. If the setting is canceled before you finish, start from step 1 again.

### Front, Center, and Rear Speaker Setting

Register the sizes of all the connected speakers.

- When you change your speakers, you need to register the information about the speakers again.

#### On the front panel ONLY:

1. Press **SETTING** repeatedly until “**FRONT SPK**” (Front Speaker), “**CENTER SPK**” (Center Speaker) or “**REAR SPK**” (Rear Speaker) appears on the display.

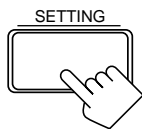

The display changes to show the current setting.

2. Turn **MULTI JOG** to select the appropriate item about the speaker selected in the above step.

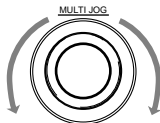

- As you turn it, the display changes to show the following:

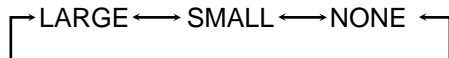

**LARGE:** Select this when the speaker size is relatively large.

**SMALL:** Select this when the speaker size is relatively small.

**NONE:** Select this when you have not connected a speaker. (Not selectable for the front speakers)

3. Repeat steps 1 and 2 to select the appropriate items for the other speakers.

#### Notes:

- Keep the following comment in mind as reference when adjusting.
  - If the size of the cone speaker unit built in your speaker is greater than 4 3/4 inches (12 cm), select “LARGE,” and if it is smaller than 4 3/4 inches (12 cm), select “SMALL.”
- If you have selected “NO” for the subwoofer setting, you can only select “LARGE” for the front speaker setting.
- If you have selected “SMALL” for the front speaker setting, you cannot select “LARGE” for the center and rear speaker settings.

## Center Delay Time Setting

Register the delay time of the sound from the center speaker, comparing that of the sound from the front speakers.

If the distance from your listening point to the center speaker is equal to that to the front speakers, select 0 msec. As the distance to the center speaker becomes shorter, increase the delay time.

- 1 msec increase (or decrease) in delay time corresponds to 11 13/16 inches (30 cm) decrease (or increase) in distance.
- When shipped from the factory, delay time is set to 0 msec.

#### On the front panel ONLY:

1. Press **SETTING** repeatedly until “**CENTER DELAY**” appears on the display.

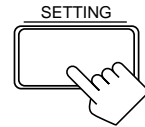

The display changes to show the current setting.

2. Turn **MULTI JOG** to select the delay time of the center speaker output.

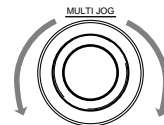

- Turn it clockwise to increase the delay time from 0 msec (“C. DELAY: 0ms”) to 5 msec (“C. DELAY: 5ms”).
- Turn it counterclockwise to decrease the delay time from 5 msec (“C. DELAY: 5ms”) to 0 msec (“C. DELAY: 0ms”).

#### Note:

Center delay time setting is not valid for the DVD MULTI playback mode.

## Rear Delay Time Setting

Register the delay time of the sound from the rear speakers, comparing that of the sound from the front speakers.

If the distance from your listening point to the rear speakers is equal to that to the front speakers, select 0 msec. As the distance to the rear speakers becomes shorter, increase the delay time.

- 1 msec increase (or decrease) in delay time corresponds to 11 13/16 inches (30 cm) decrease (or increase) in distance.
- Rear delay time for Dolby Digital and DTS Digital Surround is to be set to 5 msec.
- When shipped from the factory, delay time is set to 5 msec.

#### On the front panel ONLY:

1. Press **SETTING** repeatedly until “**REAR DELAY**” appears on the display.

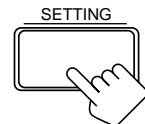

The display changes to show the current setting.

2. Turn **MULTI JOG** to select the delay time of the rear speaker output.

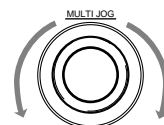

- Turn it clockwise to increase the delay time from 0 msec (“R. DELAY: 0ms”) to 15 msec (“R. DELAY: 15ms”).
- Turn it counterclockwise to decrease the delay time from 15 msec (“R. DELAY: 15ms”) to 0 msec (“R. DELAY: 0ms”).

#### Note:

Rear delay time setting is not valid for the DVD MULTI playback mode.



## Crossover Frequency Setting

Small speaker cannot reproduce the bass sound very well. So, if you have used a small speaker any for the front, center, or rear channels, this receiver automatically reallocates the bass elements, originally assigned to the channel for which you have connected the small speaker, to another channel (for which you have connected the large speaker).

To use this function properly, you need to set this crossover frequency level according to the size of the small speaker connected.

- This function takes effect only when playing back a source using Dolby Pro Logic, Dolby Digital, or DTS Digital Surround. However, if you have selected "LARGE" for all speakers (see page 14), this function will not take effect.

### On the front panel ONLY:

1. Press **SETTING** repeatedly until "CROSSOVER FRQ" (Crossover Frequency) appears on the display.

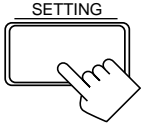

The display changes to show the current setting.

2. Turn **MULTI JOG** to select the crossover frequency level according to the size of the small speaker connected.

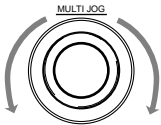

- As you turn it, the display changes to show the following:

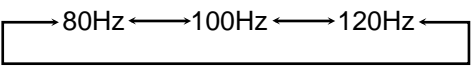

- Use the following comments as reference when adjusting.

<b>80Hz:</b>	Select this when the cone speaker unit built in the speaker is about 4 3/4 inches (12 cm).
<b>100Hz:</b>	Select this when the cone speaker unit built in the speaker is about 3 15/16 inches (10 cm).
<b>120Hz:</b>	Select this when the cone speaker unit built in the speaker is about 3 3/16 inches (8 cm).

### Note:

Crossover frequency setting is not valid for the DVD MULTI playback mode.

## Low Frequency Effect Attenuator Setting

If the bass sound is distorted while playing back a source using Dolby Digital or DTS Digital Surround, follow the procedure below.

### On the front panel ONLY:

1. Press **SETTING** repeatedly until "LFE ATT" (Low Frequency Effect Attenuator) appears on the display.

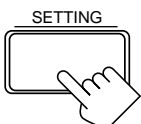

The display changes to show the current setting.

2. Turn **MULTI JOG** to select the low frequency effect attenuator level.



- As you turn it, the display changes to show the following:

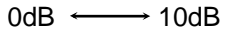

<b>0dB:</b>	Normally select this.
<b>10dB:</b>	Select this when the bass sound is distorted.

### Note:

Low frequency effect attenuator setting is not valid for the DVD MULTI playback mode.

## Dynamic Range Compression Setting

You can compress the dynamic range (difference between maximum sound and minimum sound) of the reproduced sound. This is useful when enjoying surround sound at night.

- This function takes effect only when playing back a source using Dolby Digital.

### On the front panel ONLY:

1. Press **SETTING** repeatedly until "D. RANGE COMP." (Dynamic Range Compression) appears on the display.

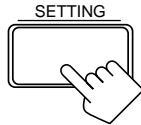

The display changes to show the current setting.

2. Turn **MULTI JOG** to select the appropriate item about the compression level.

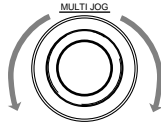

- As you turn it, the display changes to show the following:

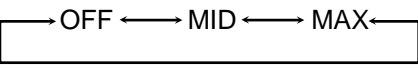

<b>OFF:</b>	Select this when you want to enjoy surround with its full dynamic range. (No effect applied)
<b>MID:</b>	Select this when you want to reduce the dynamic range a little. (Factory setting)
<b>MAX:</b>	Select this when you want to apply the compression effect fully. (Useful at night)

### Note:

Dynamic Range Compression setting is not valid for the DTS Digital Surround and DVD MULTI playback mode.

## Storing the Basic Settings and Adjustments — One Touch Operation

JVC's One Touch Operation function is used to assign and store different sound settings for each different playing source. By using this function, you do not have to change the settings every time you change the source. The stored settings for the newly selected source are automatically recalled.

The following can be stored for each source:

- Volume level (see page 10)
- Loudness (see page 11)
- Input attenuator mode (see page 11)
- Subwoofer output level (see page 11)
- Balance (see page 12)
- Analog/digital input mode (see page 13)
- SEA modes (see page 19)
- DSP modes
  - 3D-PHONIC mode settings (see page 23)
  - DAP mode settings (see page 23)
  - Surround mode settings (see page 24)
- DVD MULTI playback mode settings (see page 29)

### **On the front panel ONLY:**

**To store the sound settings**

#### **1. Press ONE TOUCH OPERATION.**

The ONE TOUCH OPERATION lamp lights up, then the previously memorized settings are recalled.



#### **2. Adjust the sound using the functions listed above.**

The newly adjusted settings are memorized.

**To recall the sound settings**

With the ONE TOUCH OPERATION lamp lit, the settings for the currently selected source are recalled when the source is selected.

**To cancel the One Touch Operation function**

Press ONE TOUCH OPERATION so that the lamp goes off. (Even though the One Touch Operation function is canceled, the recalled sound effects remain active.)

### **Notes:**

- If the source is FM or AM, you can assign a different setting for each band.
- The DSP modes and DVD MULTI playback mode cannot be used at the same time.

## Using the Sleep Timer

Using the Sleep Timer, you can fall asleep to music and know the receiver will turn off by itself rather than play all night.

### **From the remote control ONLY:**

**Press SLEEP repeatedly.**

The SLEEP indicator lights up on the display, and the shut-off time changes as follows (in minutes):

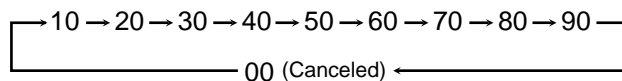

**When the shut-off time comes**

The receiver turns off automatically.

**To check or change the time remaining until the shut-off time**

Press SLEEP once.

The remaining time until the shut-off time appears in minutes.

- To change the shut-off time, press SLEEP repeatedly.

**To cancel the Sleep Timer**

Press SLEEP repeatedly until "SLEEP 00min." appears on the display. (The SLEEP indicator goes off.)

- Turning off the power also cancels the Sleep Timer.

## IMPORTANT:

When using the remote control, check to see if its remote control mode selector is set to the correct position:

**To operate this receiver**, set it to "AUDIO/TV/VCR" (except when selecting the DBS tuner as the source).

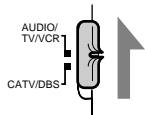

## Tuning in Stations Manually

### On the front panel:

#### 1. Turn SOURCE SELECTOR to select the band (FM or AM).

The last received station of the selected band is tuned in.

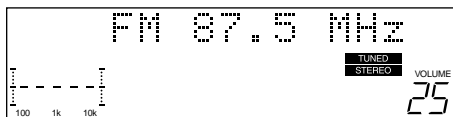
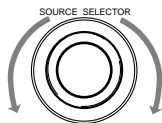

#### 2. Press FM/AM TUNING.

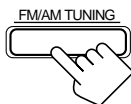

#### 3. Turn MULTI JOG until you find the frequency you want.

- Turning it clockwise increases the frequency.
- Turning it counterclockwise decreases the frequency.
- When you turn MULTI JOG quickly, the frequency keeps changing until a station is tuned in.

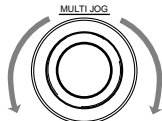

### From the remote control:

#### 1. Press FM/AM to select the band.

- Each time you press the button, the band alternates between FM and AM.



#### 2. Press TUNING UP or TUNING DOWN repeatedly until you find the frequency you want.

- When you hold the button, the frequency keeps changing until a station is tuned in.

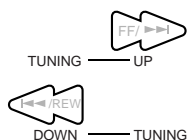

### Note:

When a station of sufficient signal strength is tuned in, the TUNED indicator lights up on the display.

When an FM stereo program is received, the STEREO indicator also lights up.

## Using Preset Tuning

Once a station is assigned to a channel number, the station can be quickly tuned. You can preset up to 30 FM and 15 AM stations.

### To store the preset stations

Before you start, remember...

- There is a time limit in doing the following steps. If the setting is canceled before you finish, start from step 1 again.

### On the front panel ONLY:

#### 1. Tune in the station you want to preset (see "Tuning in Stations Manually").

- If you want to store the FM reception mode for this station, select the FM reception mode you want. See "Selecting the FM Reception Mode" on page 18.

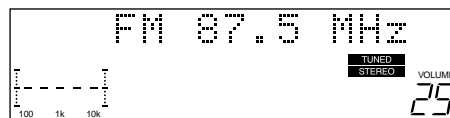

#### 2. Press TUNER/SEA MEMORY.

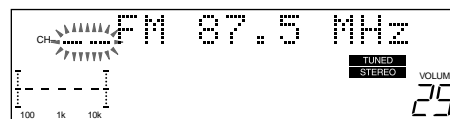

"CH-" appears and the channel number position starts flashing on the display for about 10 seconds.

#### 3. Turn MULTI JOG to select a channel number while the channel number position is flashing.

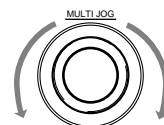

### Note:

You can use the 10 keys on the remote control to select the preset number. When using the 10 keys, be sure that they are activated for the tuner, not for the CD and others. (See page 44.)

#### 4. Press TUNER/SEA MEMORY again while the selected channel number is flashing on the display.

The selected channel number stops flashing.

The station is assigned to the selected channel number.

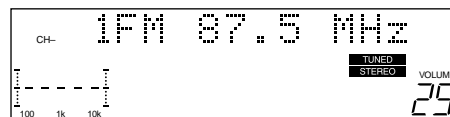
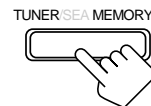

#### 5. Repeat steps 1 to 4 until you store all the stations you want.

### To erase a stored preset station

Storing a new station on a used number erases the previously stored one.

**To tune in a preset station**

**On the front panel:**

1. Turn SOURCE SELECTOR to select the band (FM or AM).

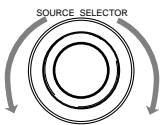

The last received station of the selected band is tuned in.

2. Press TUNER PRESET.

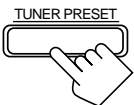

3. Turn MULTI JOG until you find the channel you want.

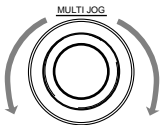

- Turning it clockwise increases the channel numbers.
- Turning it counterclockwise decreases the channel numbers.

**From the remote control:**

1. Press FM/AM.

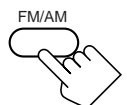

- Each time you press the button, the band alternates between FM and AM.

2. Press the 10 keys to select a preset channel number.

- For channel number 5, press 5.
- For channel number 15, press +10 then 5.
- For channel number 20, press +10 then 10.
- For channel number 30, press +10, +10, then 10.



**Note:**

When you use the 10 keys on the remote control, be sure that they are activated for the tuner, not for the CD and others. (See page 44.)

**Selecting the FM Reception Mode**

**When an FM stereo broadcast is hard to receive or noisy**

You can change the FM reception mode while receiving an FM broadcast.

- You can store the FM reception mode for each preset station.

Press FM MODE on the front panel or FM MODE/MUTING on the remote control.

- Each time you press the button, the FM reception mode alternates between "AUTO" and "MONO."

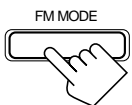

On the front panel



On the remote control

**AUTO:** When a program is broadcasted in stereo, you will hear stereo sound; when in monaural, you will hear monaural sounds. This mode is also useful to suppress static noise between stations. The MUTE AUTO indicator lights up on the display.

**MONO:** Reception will be improved although you will lose the stereo effect. In this mode, you will hear noise while tuning into the stations. The MUTE AUTO indicator goes off on the display.

**Note:**

When using the FM MODE/MUTING button on the remote control, be sure that the 10 keys are activated for tuner, not for the CD and others. (See page 44.)

**Assigning Names to Preset Stations**

You can assign a name of up to four characters to each preset station. When a preset station is tuned in, its assigned name will appear on the display.

**Before you start, remember...**

- There is a time limit in doing the following steps. If the setting is canceled before you finish, start from step 1 again.
- You can use the following characters: Space, A – Z, and 0 – 9.

**On the front panel ONLY:**

1. Tune in a preset station.

See the left.

2. Press TUNER/SEA MEMORY.

The preset channel number starts flashing for about 10 seconds.

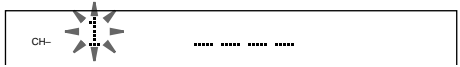
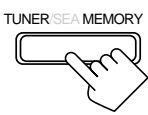

- If you turn MULTI JOG while the preset channel number is flashing, you can change the preset channel number.

3. Press TUNER PRESET, while the preset channel number is flashing.

The first character position starts flashing.

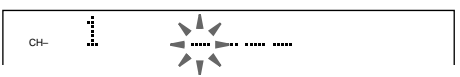
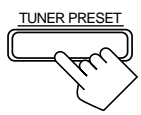

4. Turn MULTI JOG to select the first character, while the first character position is flashing.

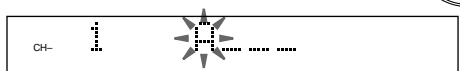

5. Press TUNER PRESET, while a character you want is flashing.

The next character position starts flashing.

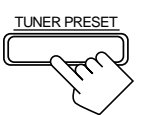

6. Repeat steps 4 and 5 to enter up to four characters.

7. Press TUNER/SEA MEMORY while the last selected character is flashing after you have assigned a name.



**To erase the input characters**

Insert spaces using the same procedure described above.

## IMPORTANT:

When using the remote control, check to see if its remote control mode selector is set to the correct position:

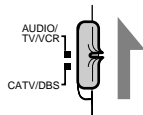

To operate this receiver, set it to "AUDIO/TV/VCR" (except when selecting the DBS tuner as the source).

## Selecting Your Favorite SEA Mode

### On the front panel:

Press SEA MODE repeatedly until the SEA mode you want appears on the display.

- Each time you press the button, the SEA mode changes as follows:

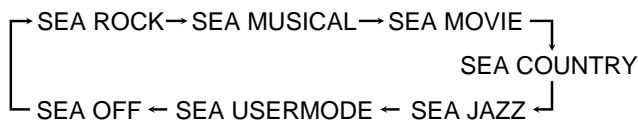

<b>SEA ROCK:</b>	Gives a heavy sound. Both high and low frequencies are boosted.
<b>SEA MUSICAL:</b>	Enhances the mid-frequency range, which the human voice is mostly made up of.
<b>SEA MOVIE:</b>	Adds breadth to sounds so you feel like you are in a movie theater.
<b>SEA COUNTRY:</b>	Enhances the high-frequency range so that instruments such as the violin and banjo are emphasized.
<b>SEA JAZZ:</b>	Gives a feeling of a live atmosphere. Good for acoustic music.
<b>SEA USERMODE:</b>	Your original SEA adjustment (see the right).
<b>SEA OFF:</b>	No SEA mode is applied (see below).

### Notes:

- The SEA modes cannot be used for recording.
- When the SEA mode is turned on, the SEA indicator lights up on the display.
- When the SEA mode is used with the DAP mode (see page 23), sounds may be distorted. If this happens, turn off the DAP mode or decrease the effect level of the DAP mode.

### To cancel the SEA mode

Press SEA MODE repeatedly until "SEA OFF" appears. The SEA indicator goes off from the display.

### From the remote control:

#### 1. Press SOUND.

The 10 keys are activated for sound adjustments.

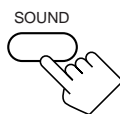

#### 2. Press SEA MODE repeatedly until the SEA mode you want appears on the display.



### To cancel the SEA mode

Press SEA MODE repeatedly until "SEA OFF" appears in step 2

## Creating Your Own SEA Mode

You can adjust and store your own SEA adjustment into memory (SEA USERMODE).

### Before you start, remember...

- There is a time limit in doing the following steps. If the setting is canceled before you finish, start from step 1 again.

### On the front panel ONLY:

If you do not want to store your adjustment, but rather want to adjust the SEA temporarily, skip step 4 below.

#### 1. Press SEA ADJUST repeatedly until the frequency range (100Hz, 1kHz or 10kHz) you want appears on the display.

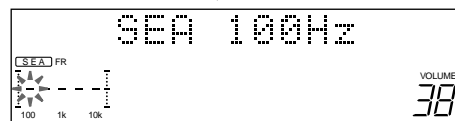

#### 2. Turn MULTI JOG to adjust the SEA level of the selected frequency range.

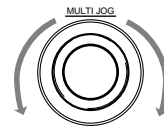

- Turning it clockwise increases the level.
- Turning it counterclockwise decreases the level.

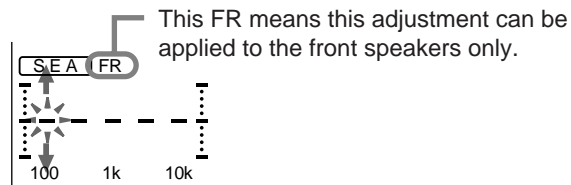

#### 3. Repeat step 1 and 2 to adjust other frequency ranges if necessary.

#### 4. Press TUNER/SEA MEMORY.

Your adjustment is stored into the SEA USERMODE.



### To recall your own SEA adjustment

Press SEA MODE repeatedly until "SEA USERMODE" appears.

### To erase a stored adjustment

Storing a new adjustment into SEA USERMODE erases the previously stored one.

### 3D-PHONIC modes

The 3D-PHONIC mode gives you such a nearly surround effect as it is reproduced through the Dolby Surround decoder, which is widely used to reproduce sounds with a feeling of movement like those experienced in movie theaters. The 3D-PHONIC mode is the result of research on sound localization technology carried out at JVC for many years. **This mode can be used when the front speakers are connected to this receiver (without respect to the rear/center speaker connection).**

- You can select either 3D ACTION or 3D THEATER to your preference when playing an analog or Linear PCM (digital) source.
- You can select either 3D DIGITAL or 3D THEATER to your preference when playing a Dolby Digital or DTS Digital Surround source.

---

**3D ACTION:** Best for action and war movies — where the action is fast and explosive.

---

**3D DIGITAL:** Reproduces multi-sound source encoded with Dolby Digital or DTS Digital Surround.

---

**3D THEATER:** Reproduces the sound field of a large theater. This mode can be selected when only front speakers are connected to this receiver and “REAR SPK” and “CENTER SPK” is set to “NONE” (see page 14).

---

#### Note on the subwoofer sound when using the 3D-PHONIC modes

Sound will or will not come out of the subwoofer according to the selected 3D-PHONIC mode.

- With “**3D ACTION**” selected: No sound comes out.
- With “**3D DIGITAL**” selected: Sound comes out if the subwoofer channel signals come into this receiver (LFE) of the signal indicators lights up — see page 10) while playing a multi-sound source encoded with Dolby Digital or DTS Digital Surround.
- With “**3D THEATER**” selected:
  - If “FRONT SPK” is set to “SMALL,” sound comes out while playing any source.
  - If “FRONT SPK” is set to “LARGE,” sound comes out only if the subwoofer channel signals come into this receiver (LFE) of the signal indicators lights up — see page 10) while playing a multi-sound source encoded with Dolby Digital or DTS Digital Surround.

### DAP modes

The sound heard in a concert hall or club consists of direct sound and indirect sound — early reflections and reflections from behind. Direct sounds reach the listener directly without any reflection. On the other hand, indirect sounds are delayed by the distances of the ceiling and walls. These direct sounds and indirect sounds are the most important elements of the acoustic surround effects. The DAP mode can create these important elements, and gives you a real “being there” feeling. **This mode can be used when the front speakers are connected to this receiver (without respect to the rear/center speaker connection).**

You can select one of the following to your preference.

---

**LIVE CLUB:** Gives the feeling of a live music club with a low ceiling.

---

**DANCE CLUB:** Gives a throbbing bass beat.

---

**HALL:** Gives clear vocal and the feeling of a concert hall.

---

**PAVILION:** Gives the spacious feeling of a pavilion with a high ceiling.

---

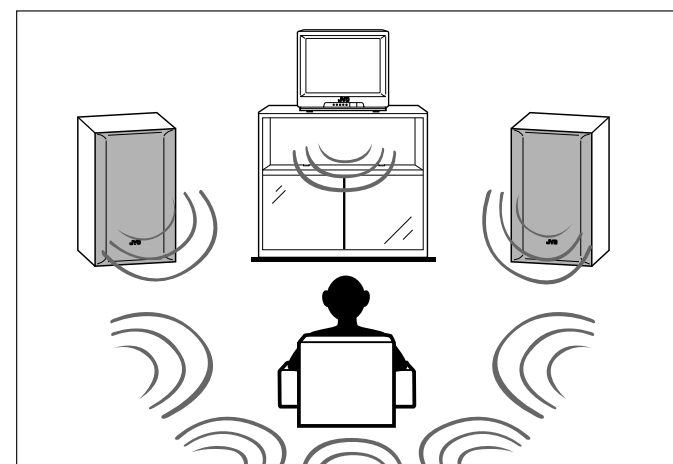
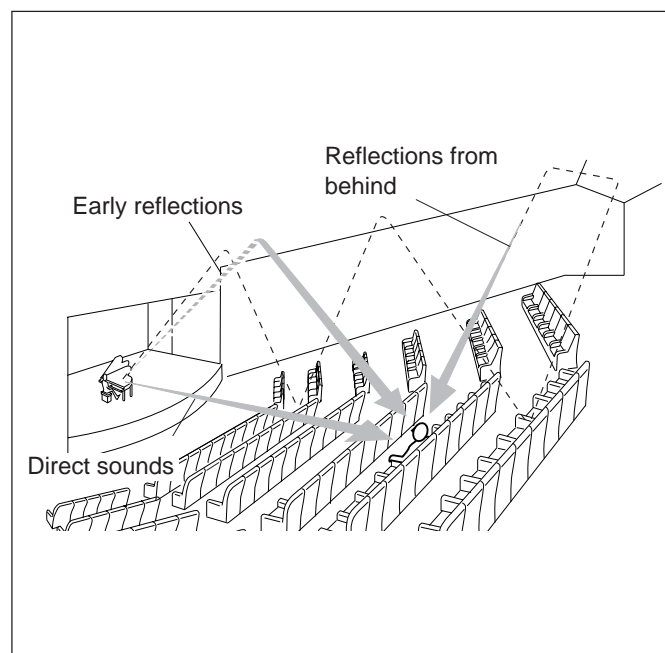

## Surround modes

With this receiver, you can use three types of the Surround mode. **Following modes cannot be used when only the front speakers are connected to this receiver (without the rear speakers or center speaker).**

### ***Dolby Surround (Dolby Digital and Dolby Pro Logic)\****

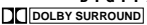
Used to watch the soundtracks of software encoded with Dolby Digital (bearing the mark ) or with Dolby Surround (bearing the mark ) .  
Dolby Digital and Dolby Pro Logic can be selected automatically according to software played back and the speaker arrangement you have done.

- To enjoy the software encoded with Dolby Digital, you must connect the source component using the digital terminal on the rear of this receiver. (See page 8.)

### ***DTS Digital Surround\*\****

DTS Digital Surround is a discrete 5.1 channel digital audio format available on CD, LD, and DVD software.



To watch the soundtracks of video software bearing the mark , the receiver can provide you with DTS Digital Surround decoder. DTS Digital Surround is automatically selected according to software played back and the speaker arrangement you have done.



- To enjoy the software encoded with DTS Digital Surround, you must connect the source component using the digital terminal on the rear of this receiver. (See page 8.)

### ***Note:***

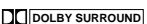
*A CD encoded with DTS Digital Surround cannot be played back through this receiver.*

### ***JVC Theater Surround***

In order to reproduce a more realistic sound field in your listening room while playing soundtracks of software encoded with Dolby Digital (bearing the mark ) , with Dolby Surround (bearing the mark ) , or with DTS Digital Surround (bearing the mark ) , you can use JVC Theater Surround.

- When playing a source encoded with Dolby Digital (bearing the mark ) or with DTS Digital Surround (bearing the mark ) , “DIG THEATER” is selected automatically.
- When playing a source encoded with Dolby Surround (bearing the mark ) , “THEATER” is selected automatically.

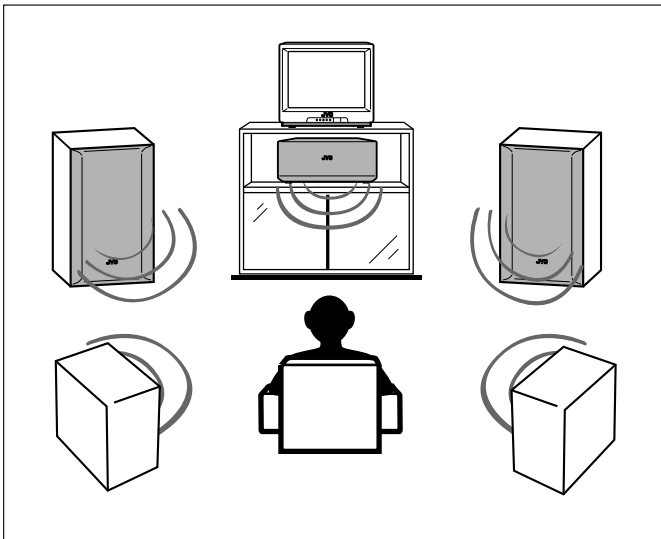

### ***Notes:***

- The DSP modes have no effect on monaural sources.
- The DSP modes cannot be used for recording an analog source.
- When you select “DVD MULTI” as the source to play, you cannot select or adjust the DSP modes.
- The PRO LOGIC indicator lights up when the Dolby Pro Logic decoder built in this receiver is activated.
- The  DIGITAL indicator lights up when the signals encoded with Dolby Digital come into the receiver.
- The Dolby Pro Logic decoder is used not only for the analog sources but also for the sources encoded with Dolby Digital or DTS Digital Surround in the following cases:
  - When only front channel signals are encoded.
  - When front channel and monaural rear channel signals are encoded.

### ***IMPORTANT:***

Before recording a digital source, turn off the DSP mode.

### **DVD MULTI Playback Mode**

This receiver provides the DVD MULTI playback mode for reproducing the analog discrete 5.1 channel output mode of the DVD player or other equipment.

You can adjust the DVD MULTI playback mode while playing back a video software such as a DVD using the analog discrete 5.1 channel output mode.

- For the DVD MULTI playback mode connection, see page 7.
- For details on the DVD MULTI playback mode, see page 29.

\* Manufactured under license from Dolby Laboratories. “Dolby,” “Pro Logic,” and the double-D symbol are trademarks of Dolby Laboratories. Confidential Unpublished Works. ©1992–1998 Dolby Laboratories, Inc. All rights reserved.

\*\* Manufactured under license from Digital Theater Systems, Inc. US Pat. No. 5,451,942 and other world-wide patents issues and pending. “DTS” and “DTS Digital Surround” are trademarks of Digital Theater Systems, Inc. ©1996 Digital Theater Systems, Inc. All rights reserved.

# Available DSP Modes According to the Speaker Arrangement

Available DSP modes will vary depending on how many speakers are used with this receiver.

**Make sure that you have set the speaker information correctly (see page 14).**

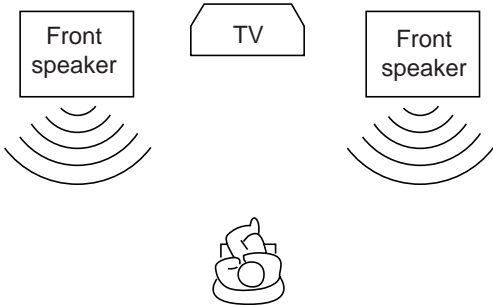
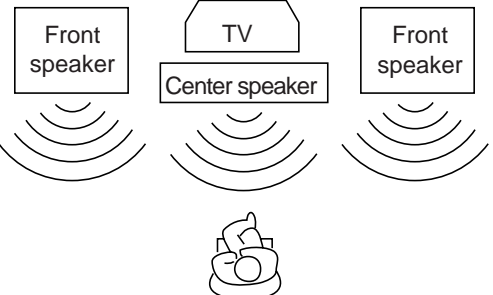
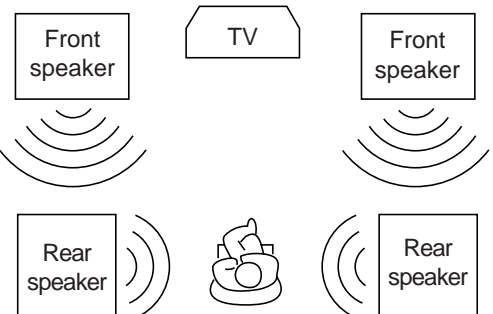
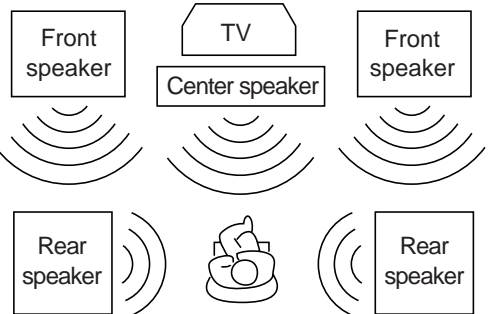
Speaker arrangements	Available DSP modes
	<p>Each time you press DSP MODE on the front panel or SURROUND MODE on the remote control, the DSP modes change as follows:</p> <ul style="list-style-type: none"> <li>• 3D THEATER</li> <li>• LIVE CLUB</li> <li>• DANCE CLUB</li> <li>• HALL</li> <li>• PAVILION</li> <li>• 3D ACTION (or 3D DIGITAL)</li> <li>• DSP OFF (DSP mode is canceled)</li> </ul>
	<p>Each time you press DSP MODE on the front panel or SURROUND MODE on the remote control, the DSP modes change as follows:</p> <div style="display: flex; justify-content: space-between;"> <div style="width: 45%;"> <p><b>By pressing DSP MODE:</b></p> <ul style="list-style-type: none"> <li>• THEATER (or DIG THEATER)</li> <li>• LIVE CLUB</li> <li>• DANCE CLUB</li> <li>• HALL</li> <li>• PAVILION</li> <li>• 3D ACTION (or 3D DIGITAL)</li> <li>• DSP OFF (DSP mode is canceled)</li> </ul> </div> <div style="width: 45%;"> <p><b>By pressing SURROUND MODE:</b></p> <ul style="list-style-type: none"> <li>• DOLBY/DTS SURROUND (DOLBY PRO LOGIC, DOLBY DIGITAL, or DTS SURROUND)</li> <li>• THEATER (or DIG THEATER)</li> <li>• LIVE CLUB</li> <li>• DANCE CLUB</li> <li>• HALL</li> <li>• PAVILION</li> <li>• 3D ACTION (or 3D DIGITAL)</li> <li>• DSP OFF (DSP mode is canceled)</li> </ul> </div> </div>
	<div style="border: 1px solid black; padding: 5px; margin-bottom: 10px;"> <p><b>To activate the Surround mode,</b> press DOLBY/DTS SURROUND ON/OFF button so that the lamp on the button lights up.</p> </div> <div style="border: 1px solid black; padding: 5px;"> <p><b>To activate the Surround mode,</b> you can also use the SURROUND ON/OFF button.</p> </div>
	<div style="border: 1px solid black; padding: 5px;"> <p><b>Note on the center speaker sound when using the DAP modes:</b>            Sounds come out of the center speaker only if the following take place at the same time;</p> <ul style="list-style-type: none"> <li>• If "CENTER SPK" is set to "LARGE" or "SMALL."</li> <li>• If the center channel signals come into this receiver (C of the signal indicators lights up — see page 10) while playing a multi-sound source encoded with Dolby Digital or DTS Digital Surround.</li> </ul> <p>In this case, you cannot adjust the center speaker output level.</p> </div>



## IMPORTANT:

When using the remote control, check to see if its remote control mode selector is set to the correct position:

To operate this receiver, set it to "AUDIO/TV/VCR" (except when selecting the DBS tuner as the source).

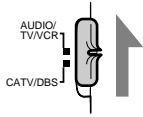

## 3. Press EFFECT to select an effect level you want.

- Each time you press the button, the effect level changes as follows:

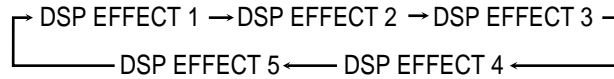

As the number increases, the selected 3D-PHONIC mode becomes stronger.

## Adjusting the 3D-PHONIC Modes

Once you have adjusted the 3D-PHONIC modes, the adjustment is memorized for each 3D-PHONIC mode.

### Before you start, remember...

- Make sure that you have set the speaker information correctly (see page 14).
- There is a time limit in doing the following steps. If the setting is canceled before you finish, start from step 1 again.

### On the front panel:

- Press **DSP MODE** repeatedly until "3D ACTION (or 3D DIGITAL)" or "3D THEATER" appears on the display.



The 3D-PHONIC, DSP, PRO LOGIC and selected 3D-PHONIC mode indicators also light up on the display.

- Adjust the effect level.

- Press **BALANCE/SURROUND ADJUST** repeatedly until "DSP EFFECT" appears on the display.



The display changes to show the current setting.

- Turn **MULTI JOG** to select the effect level.

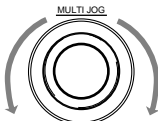

- As you turn it, the effect level changes as follows:

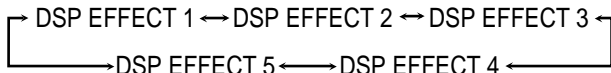

As the number increases, the selected 3D-PHONIC mode becomes stronger.

### From the remote control:

- Press **SURROUND MODE** repeatedly until "3D ACTION (or 3D DIGITAL)" or "3D THEATER" appears on the display.



The 3D-PHONIC, DSP, PRO LOGIC and selected 3D-PHONIC mode indicators also light up on the display.

- Press **SOUND**.

The 10 keys are activated for sound adjustments.

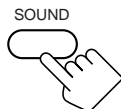

## Adjusting the DAP Modes

Once you have adjusted the DAP modes, the adjustment is memorized for each DAP mode.

### Before you start, remember...

- Make sure that you have set the speaker information correctly (see page 14).
- There is a time limit in doing the following steps. If the setting is canceled before you finish, start from step 1 again.
- You cannot adjust the rear speaker output level when you have set "REAR SPK" to "NONE." See page 14.
- When the DAP mode is used with the SEA mode (see page 19), sounds may be distorted. If this happens, turn off the SEA mode.

### On the front panel:

- Press **DSP MODE** repeatedly until the DAP mode — **LIVE CLUB, DANCE CLUB, HALL, or PAVILION** — appears on the display.



The DSP and the selected DAP mode indicators also light up on the display.

- When you have set "REAR SPK" to "NONE," the 3D-PHONIC indicator also lights up.

- Adjust the speaker output levels.

- Press **BALANCE/SURROUND ADJUST** repeatedly until one of the indications appears on the display.



"REAR L LEVEL":

To adjust the left rear speaker level.

"REAR R LEVEL":

To adjust the right rear speaker level.

- Turn **MULTI JOG** to adjust the selected speaker output level (from -10 dB to +10 dB).

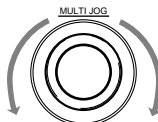

- Repeat 1) and 2) to adjust the other speaker output level.

## Adjusting the Surround Modes

Once you have adjusted the Surround modes, the adjustment is memorized for each Surround mode.

### Dolby and DTS Surround adjustments

Before you start, remember...

- Make sure that you have set the speaker information correctly (see page 14).
- There is a time limit in doing the following steps. If the setting is canceled before you finish, start from step 1 again.
- You cannot adjust the rear speaker output levels when you have set "REAR SPK" to "NONE." See page 14.
- You cannot adjust the center speaker output level and center tone when you have set "CENTER SPK" to "NONE." See page 14.

**From the remote control:**

1. Press **SURROUND MODE** repeatedly until the mode — **PRO LOGIC, DOLBY DIGITAL, or DTS SURROUND** — appears on the display.

- When "PRO LOGIC" is selected, the PRO LOGIC indicator lights up on the display.

**Note:**

You can also press **SURROUND ON/OFF** to activate an appropriate Surround mode — **PRO LOGIC, DOLBY DIGITAL, or DTS SURROUND**. Each time you press the button, the Surround mode turns on and off alternately.

2. Press **SOUND**.

The 10 keys are activated for sound adjustments.

3. Press **TEST** to check the speaker output balance.

"TEST TONE L" starts flashing on the display, and a test tone comes out of the speakers in the following order:

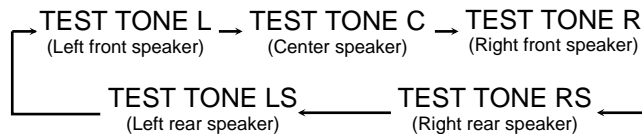

BALANCE SURROUND  
ADJUST

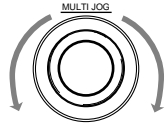

### 3. Adjust the effect level.

- 1) Press **BALANCE/SURROUND ADJUST** repeatedly until "DSP EFFECT" appears on the display. The display changes to show the current setting.
- 2) Turn **MULTI JOG** to select the effect level.
  - As you turn it, the effect level changes as follows:

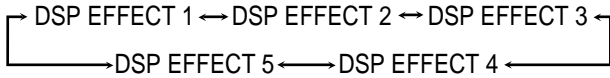

As the number increases, the selected DAP mode becomes stronger.

**From the remote control:**

1. Press **SURROUND MODE** repeatedly until the DAP mode — **LIVE CLUB, DANCE CLUB, HALL, or PAVILION** — appears on the display.

The DSP and the selected DAP mode indicators also light up on the display.



2. Press **SOUND**.

The 10 keys are activated for sound adjustments.

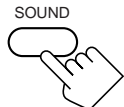

3. Adjust the speaker output levels.

- To adjust the left rear speaker level, press REAR•L -/+ (from -10 dB to +10 dB).
- To adjust the right rear speaker level, press REAR•R -/+ (from -10 dB to +10 dB).

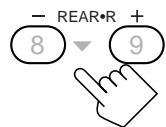
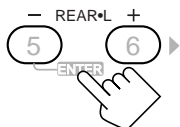

4. Press **EFFECT** to select an effect level you want.

- Each time you press the button, the effect level changes as follows:

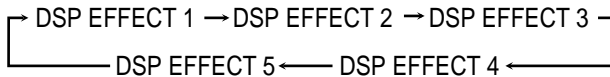

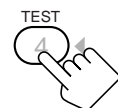
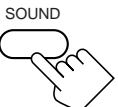

As the number increases, the selected DAP mode becomes stronger.

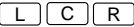

## Notes:

- You can adjust the speaker output levels without outputting the test tone.
- No test tone comes out of the center speaker when "CENTER SPK" is set to "NONE" (see page 14).
- No test tone comes out of the rear speakers when "REAR SPK" is set to "NONE" (see page 14).
- If the TV is turned on and the proper video input is selected on the TV, the test tone screen will appear on the TV.
- The signal indicators also light on the display while the test tone comes out of the speakers.

L: Lights when the test tone comes out of the left front speaker. 

C: Lights when the test tone comes out of the center speaker. 

R: Lights when the test tone comes out of the right front speaker.

RS: Lights when the test tone comes out of the right rear speaker.

LS: Lights when the test tone comes out of the left rear speaker.

## 4. Adjust the speaker output levels.

- To adjust the center speaker level, press CNTR +/- (from -10 dB to +10 dB).
- To adjust the left rear speaker level, press REAR•L +/- (from -10 dB to +10 dB).
- To adjust the right rear speaker level, press REAR•R +/- (from -10 dB to +10 dB).

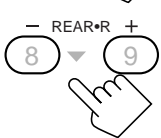
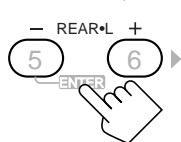
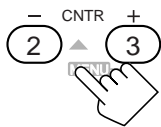

## 5. Press TEST again to stop the test tone.

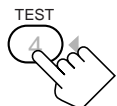

## 6. Press CNTR TONE to select the center tone level you want.



The center tone adjustment affects the mid-frequency range, which the human voice is mostly made up of.

- Each time you press the button, the display changes to show the following:

SOFT 2 → SOFT 1 → FLAT → SHARP 1 → SHARP 2

Adjusted levels are also shown on the equalizer display.

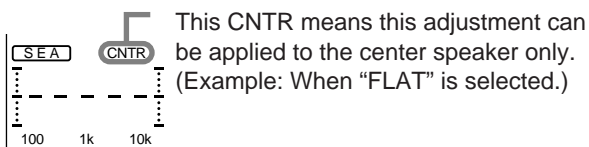

To make the dialogue clearer, select "SHARP 1" (little) or "SHARP 2" (much).

To make the dialogue softer, select "SOFT 1" (little) or "SOFT 2" (much).

When "FLAT" is selected, no adjustment is applied.

## On the front panel:

You can also use the buttons on the front panel to adjust the Surround modes. However, no test tone is available when using the buttons on the front panel. So, make adjustments while listening to the sound of the source played back.

## 1. Press DOLBY/DTS SURROUND ON/OFF to activate an appropriate Surround mode — PRO LOGIC, DOLBY DIGITAL or DTS SURROUND.

DOLBY/DTS SURROUND ON/OFF



- Each time you press the button, the Surround mode turns on and off alternately.
- When "PRO LOGIC" is selected, the PRO LOGIC indicator lights up on the display.

## 2. Adjust the speaker output levels.

### 1) Press BALANCE/SURROUND ADJUST repeatedly until one of the indications appears on the display.

"CENTER LEVEL":

To adjust the center speaker level.

"REAR L LEVEL":

To adjust the left rear speaker level.

"REAR R LEVEL":

To adjust the right rear speaker level.

### 2) Turn MULTI JOG to adjust the selected speaker output level (from -10 dB to +10 dB).

### 3) Repeat 1) and 2) to adjust the other speaker output levels.

BALANCE/SURROUND ADJUST

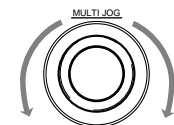

## 3. Adjust the center tone.

### 1) Press BALANCE/SURROUND ADJUST repeatedly until "CENTER TONE" appears on the display.

The display changes to show the current setting.

### 2) Turn MULTI JOG to select the center tone level you want.

- As you turn it, the display changes to show the following:

SOFT 2 → SOFT 1 → FLAT → SHARP 1 → SHARP 2

BALANCE/SURROUND ADJUST

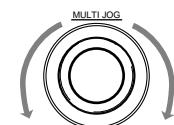
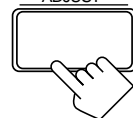

# JVC Theater Surround adjustments

Before you start, remember...

- Make sure that you have set the speaker information correctly (see page 14).
- There is a time limit in doing the following steps. If the setting is canceled before you finish, start from step 1 again.
- You cannot adjust the rear speaker output levels when you have set "REAR SPK" to "NONE." See page 14.
- You cannot adjust the center speaker output level and center tone when you have set "CENTER SPK" to "NONE." See page 14.

## From the remote control:

1. Press **SURROUND MODE** repeatedly until "THEATER" or "DIG THEATER" appears on the display.



- When "THEATER" is selected, the PRO LOGIC, DSP, and THEATER indicators also light up on the display.
- When "DIG THEATER" is selected, the DSP and THEATER indicators also light up on the display.

2. Press **SOUND**.

The 10 keys are activated for sound adjustments.

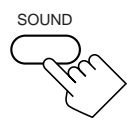

3. Press **TEST** to check the speaker output balance.

"TEST TONE L" starts flashing on the display, and a test tone comes out of the speakers in the following order:

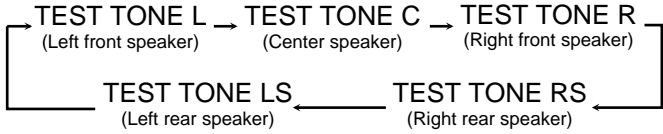
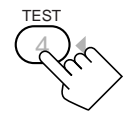

### Notes:

- You can adjust the speaker output levels without outputting the test tone.
- No test tone comes out of the center speaker when "CENTER SPK" is set to "NONE" (see page 14).
- No test tone comes out of the rear speakers when "REAR SPK" is set to "NONE" (see page 14).
- If the TV is turned on and the proper video input is selected on the TV, the test tone screen will appear on the TV.
- The signal indicators also light on the display while the test tone comes out of the speakers.

L: Lights when the test tone comes out of the left front speaker. L C R

C: Lights when the test tone comes out of the center speaker. LS RS

R: Lights when the test tone comes out of the right front speaker.

RS: Lights when the test tone comes out of the right rear speaker.

LS: Lights when the test tone comes out of the left rear speaker.

4. Adjust the speaker output levels.

- To adjust the center speaker level, press CNTR +/- (from -10 dB to +10 dB).
- To adjust the left rear speaker level, press REAR•L +/- (from -10 dB to +10 dB).
- To adjust the right rear speaker level, press REAR•R +/- (from -10 dB to +10 dB).

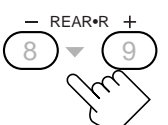
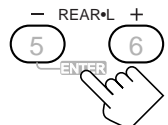
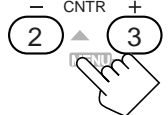

5. Press **TEST** again to stop the test tone.



6. Press **CNTR TONE** to select the center tone level you want.

The center tone adjustment affects the mid-frequency range, which the human voice is mostly made up of.



- Each time you press the button, the display changes to show the following:



Adjusted levels are also shown on the equalizer display.

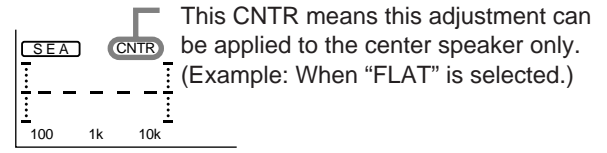

To make the dialogue clearer, select "SHARP 1" (little) or "SHARP 2" (much).

To make the dialogue softer, select "SOFT 1" (little) or "SOFT 2" (much).

When "FLAT" is selected, no adjustment is applied.

7. Press **EFFECT** to select an effect level you want.

- Each time you press the button, the effect level changes as follows:

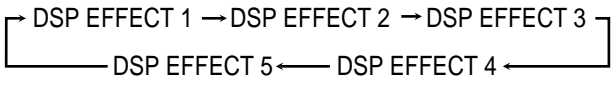

As the number increases, JVC Theater Surround becomes stronger.

## On the front panel:

You can also use the buttons on the front panel to adjust the Surround modes. However, no test tone is available when using the buttons on the front panel. So, make adjustments while listening to the sound of the source played back.

### 1. Press DSP MODE repeatedly until “THEATER” or “DIG THEATER” appears on the display.

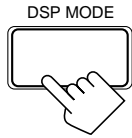

- When “THEATER” is selected, the PRO LOGIC, DSP, and THEATER indicators light up on the display.
- When “DIG THEATER” is selected, the DSP and THEATER indicators light up on the display.

### 2. Adjust the speaker output levels.

#### 1) Press BALANCE/SURROUND ADJUST repeatedly until one of the indications appears on the display.



“CENTER LEVEL”:

To adjust the center speaker level.

“REAR L LEVEL”:

To adjust the left rear speaker level.

“REAR R LEVEL”:

To adjust the right rear speaker level.

#### 2) Turn MULTI JOG to adjust the selected speaker output level (from -10 dB to +10 dB).

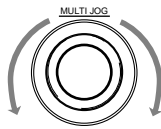

#### 3) Repeat 1) and 2) to adjust the other speaker output levels.

### 3. Adjust the center tone.

#### 1) Press BALANCE/SURROUND ADJUST repeatedly until “CENTER TONE” appears on the display.



The display changes to show the current setting.

#### 2) Turn MULTI JOG to select the center tone level you want.

- As you turn it, the display changes to show the following:

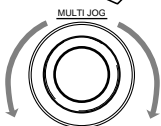

SOFT 2 ↔ SOFT 1 ↔ FLAT ↔ SHARP 1 ↔ SHARP 2

### 4. Adjust the effect level.

#### 1) Press BALANCE/SURROUND ADJUST repeatedly until “DSP EFFECT” appears on the display.



The display changes to show the current setting.

#### 2) Turn MULTI JOG to select the effect level.

- As you turn it, the effect level changes as follows:

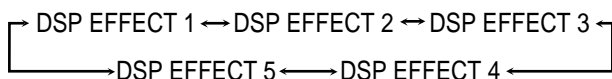
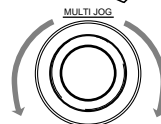

As the number increases, JVC Theater Surround becomes stronger.

## Activating the DSP Modes

You can use only one DSP mode at a time. When a DSP mode is activated, another DSP mode is canceled if in use.

### For Dolby Pro Logic, Dolby Digital, and DTS Digital Surround

#### On the front panel:

#### 1. Press DOLBY/DTS SURROUND ON/OFF so that the lamp on the button lights up.

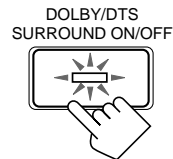

- Each time you press the button, the Dolby/DTS Surround turns on and off alternately.

#### 2. Select and play a sound source.

- To enjoy Dolby Pro Logic, play back a software encoded with Dolby Surround and labeled with mark.
- To enjoy Dolby Digital, play back a software encoded with Dolby Digital and labeled with mark.
- To enjoy DTS Digital Surround, play back a software encoded with DTS Digital Surround and labeled with mark.

#### To cancel the Dolby/DTS Surround mode

Press DOLBY/DTS SURROUND ON/OFF again so that the lamp on the button goes off. (“SURROUND OFF” appears on the display.)



#### From the remote control:

#### 1. Press SURROUND ON/OFF so that the lamp on the DOLBY/DTS SURROUND ON/OFF button on the front panel lights up.



- Each time you press the button, the Dolby/DTS Surround turns on and off alternately.
- You can also turn on Dolby/DTS Surround by pressing SURROUND MODE. (See page 22 for more details.)

#### 2. Select and play a sound source.

- To enjoy Dolby Pro Logic, play back a software encoded with Dolby Surround and labeled with mark.
- To enjoy Dolby Digital, play back a software encoded with Dolby Digital and labeled with mark.
- To enjoy DTS Digital Surround, play back a software encoded with DTS Digital Surround and labeled with mark.

#### To cancel the Dolby/DTS Surround mode

Press SURROUND ON/OFF again. (“SURROUND OFF” appears on the display.)





This receiver provides the DVD MULTI playback mode for reproducing the analog discrete output mode of the DVD player. Before playing back a DVD, refer also to the manual supplied with the DVD player.

## IMPORTANT:

When using the remote control, check to see if its remote control mode selector is set to the correct position:

**To operate this receiver**, set it to "AUDIO/TV/VCR" (except when selecting the DBS tuner as the source).

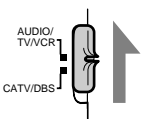

## Activating the DVD MULTI Playback Mode

You can adjust the DVD MULTI playback mode while playing back a DVD using the analog discrete output mode on the DVD player. Once you made adjustments, the receiver memorizes the adjustments until you change them. You also need to set the DVD player to the analog discrete output mode.

### Before you start, remember...

- There is a time limit in doing the following steps. If the setting is canceled before you finish, start from step 1 again.

### On the front panel:

1. Turn **SOURCE SELECTOR** until "DVD MULTI" appears on the display.

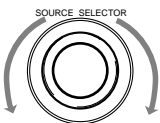

### Note:

When you select "DVD MULTI" as the source to play, the DSP mode is canceled temporarily, and the DOLBY/DTS SURROUND ON/OFF and DSP MODE buttons do not work.

2. Select the analog discrete output mode on the DVD player, and start playing a DVD.

- Refer to the manual supplied with the DVD player.

If you need to make any adjustment, go to the following steps.

3. Adjust the speaker output levels.

- 1) Press **BALANCE/SURROUND ADJUST** repeatedly until one of the indications appears on the display.

"CENTER LEVEL":

To adjust the center speaker level.

"REAR L LEVEL":

To adjust the left rear speaker level.

"REAR R LEVEL":

To adjust the right rear speaker level.

- 2) Turn **MULTI JOG** to adjust the selected speaker output level (from -10 dB to +10 dB).

- 3) Repeat 1) and 2) to adjust the other speaker output levels.

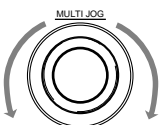

4. Adjust the center tone.

- 1) Press **BALANCE/SURROUND ADJUST** repeatedly until "CENTER TONE" appears on the display.

The display changes to show the current setting.

- 2) Turn **MULTI JOG** to select the center tone level you want.

The center tone adjustment affects the mid-frequency range, which the human voice is mostly made up of.

- As you turn it, the display changes to show the following:

SOFT 2 → SOFT 1 → FLAT → SHARP 1 → SHARP 2

Adjusted levels are also shown on the equalizer display.

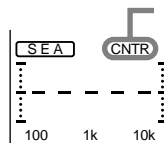

This CNTR means this adjustment can be applied to the center speaker only. (Example: When "FLAT" is selected.)

**To make the dialogue clearer**, select "SHARP 1" (little) or "SHARP 2" (much).

**To make the dialogue softer**, select "SOFT 1" (little) or "SOFT 2" (much).

When "FLAT" is selected, no adjustment is applied.

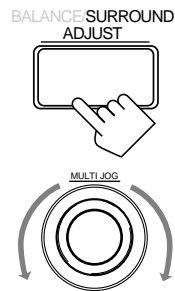

**From the remote control:**

**1. Press DVD MULTI so that “DVD MULTI” appears on the display.**



**Note:**

When you select “DVD MULTI” as the source to play, the DSP mode is canceled temporarily, and the SURROUND ON/OFF and SURROUND MODE buttons do not work.

**2. Select the analog discrete output mode on the DVD player, and start playing a DVD.**

- Refer to the manual supplied with the DVD player.

**If you need to make any adjustment, go to the following steps.**

**3. Press SOUND.**

The 10 keys are activated for adjusting the sound.

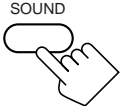

**4. Adjust the speaker output levels.**

- To adjust the center speaker level, press CNTR +/- (from -10 dB to +10 dB).
- To adjust the left rear speaker level, press REAR•L +/- (from -10 dB to +10 dB).
- To adjust the right rear speaker level, press REAR•R +/- (from -10 dB to +10 dB).

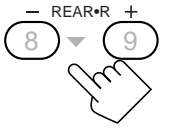
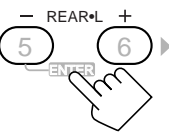
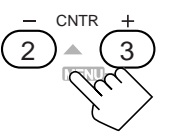

**5. Press CNTR TONE to select the center tone level you want.**

- Each time you press the button, the display changes to show the following:



SOFT 2 → SOFT 1 → FLAT → SHARP 1 → SHARP 2

**MEMO**

Use this column to write down your DVD MULTI playback mode adjustments for your future reference.

Blank lined area for writing notes.



You can use the Menus on the TV screen to control the receiver.

To use this function, you need to connect the TV to the MONITOR OUT jack on the rear panel (see page 7), and set the TV's input mode to the proper position to which the receiver is connected.

- When the TV's input mode is incorrect; for example, a different video input or TV tuner mode is selected, you cannot show the Menus on the TV screen.

On-Screen Operation buttons (on the remote control)

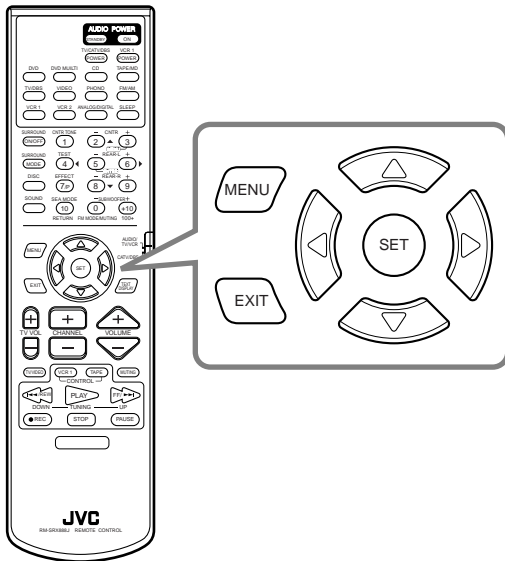

## Selecting Different Sources for Picture and Sound (Also see page 10)

### 1. Press MENU.

The MAIN MENU appears on the TV.

- Pressing one of the  $\Delta / \nabla / \triangleleft / \triangleright$  buttons also displays the MAIN MENU.

### 2. Press $\Delta / \nabla$ to move to "VISUAL."

### 3. Press $\triangleleft / \triangleright$ to select a different video source.

### 4. When you finish, press EXIT.

The menu disappears from the TV.

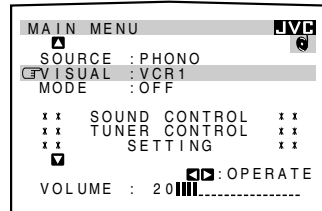

## Activating the DSP Modes (Also see page 27)

### 1. Press MENU.

The MAIN MENU appears on the TV.

- Pressing one of the  $\Delta / \nabla / \triangleleft / \triangleright$  buttons also displays the MAIN MENU.

### 2. Press $\Delta / \nabla$ to move to "MODE."

### 3. Press $\triangleleft / \triangleright$ to select the DSP mode you want to use.

### 4. When you finish, press EXIT.

The menu disappears from the TV.

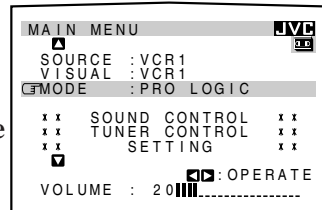

## Selecting the Source to Play (Also see page 9)

### 1. Press MENU.

The MAIN MENU appears on the TV.

- Pressing one of the  $\Delta / \nabla / \triangleleft / \triangleright$  buttons also displays the MAIN MENU.

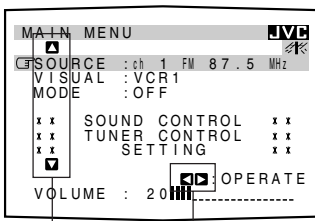

Shows the buttons you can use on the current menu. In this case, use  $\Delta / \nabla$  to move up and down, and  $\triangleleft / \triangleright$  to select, adjust or set the item.

### Note:

The on-screen display will disappear if no operation is done for about 1 minute.

### 2. Press $\Delta / \nabla$ to move to "SOURCE."

### 3. Press $\triangleleft / \triangleright$ to select the source.

### 4. When you finish, press EXIT.

The menu disappears from the TV.

## Adjusting the Front Speaker Output Balance (Also see page 12)

### 1. Press MENU.

The MAIN MENU appears on the TV.

- Pressing one of the  $\Delta / \nabla / \triangleleft / \triangleright$  buttons also displays the MAIN MENU.

### 2. Press $\Delta / \nabla$ to move to "SOUND CONTROL," then press $\triangleleft / \triangleright$ .

The SOUND CONTROL menu appears.

### 3. Press $\Delta / \nabla$ to move to "BAL." (Balance).

### 4. Press $\triangleleft / \triangleright$ to adjust the balance.

### 5. When you finish, press EXIT repeatedly until the menu disappears from the TV.

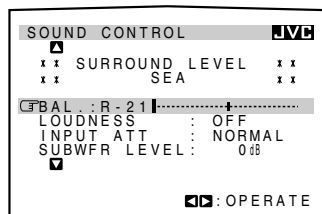

## ■ Listening at Low Volume (Loudness)

(Also see page 11)

### 1. Press MENU.

The MAIN MENU appears on the TV.

- Pressing one of the  $\Delta$  /  $\nabla$  /  $\triangleleft$  /  $\triangleright$  buttons also displays the MAIN MENU.

### 2. Press $\Delta$ / $\nabla$ to move $\leftarrow$ to “SOUND CONTROL,” then press $\triangleleft$ / $\triangleright$ .

The SOUND CONTROL menu appears.

### 3. Press $\Delta$ / $\nabla$ to move $\leftarrow$ to “LOUDNESS.”

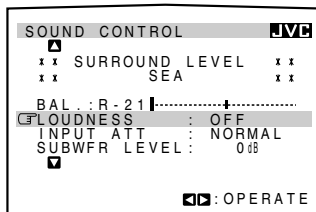

### 4. Press $\triangleleft$ / $\triangleright$ to turn the loudness “ON” or “OFF.”

### 5. When you finish, press EXIT repeatedly until the menu disappears from the TV.

## ■ Attenuating the Input Signal

(Also see page 11)

### 1. Press MENU.

The MAIN MENU appears on the TV.

- Pressing one of the  $\Delta$  /  $\nabla$  /  $\triangleleft$  /  $\triangleright$  buttons also displays the MAIN MENU.

### 2. Press $\Delta$ / $\nabla$ to move $\leftarrow$ to “SOUND CONTROL,” then press $\triangleleft$ / $\triangleright$ .

The SOUND CONTROL menu appears.

### 3. Press $\Delta$ / $\nabla$ to move $\leftarrow$ to “INPUT ATT.”

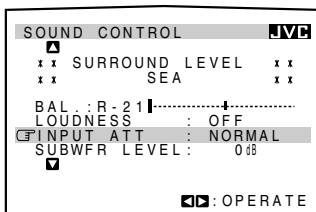

### 4. Press $\triangleleft$ / $\triangleright$ to turn the Input Attenuator mode “ATT ON” or “NORMAL.”

### 5. When you finish, press EXIT repeatedly until the menu disappears from the TV.

## ■ Adjusting the Subwoofer Output Level

(Also see page 11)

### 1. Press MENU.

The MAIN MENU appears on the TV.

- Pressing one of the  $\Delta$  /  $\nabla$  /  $\triangleleft$  /  $\triangleright$  buttons also displays the MAIN MENU.

### 2. Press $\Delta$ / $\nabla$ to move $\leftarrow$ to “SOUND CONTROL,” then press $\triangleleft$ / $\triangleright$ .

The SOUND CONTROL menu appears.

### 3. Press $\Delta$ / $\nabla$ to move $\leftarrow$ to “SUBWFR LEVEL.”

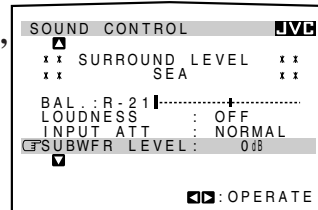

### 4. Press $\triangleleft$ / $\triangleright$ to adjust the subwoofer output level.

### 5. When you finish, press EXIT repeatedly until the menu disappears from the TV.

## ■ Adjusting the DSP Modes

(Also see pages 23 – 27)

### 1. Press MENU.

The MAIN MENU appears on the TV.

- Pressing one of the  $\Delta$  /  $\nabla$  /  $\triangleleft$  /  $\triangleright$  buttons also displays the MAIN MENU.

### 2. Press $\Delta$ / $\nabla$ to move $\leftarrow$ to “MODE.”

### 3. Press $\triangleleft$ / $\triangleright$ to select the DSP mode you want to adjust.

- In this example, “THEATER” is selected.

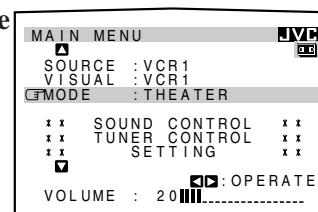

### 4. Press $\Delta$ / $\nabla$ to move $\leftarrow$ to “SOUND CONTROL,” then press $\triangleleft$ / $\triangleright$ .

The SOUND CONTROL menu appears.

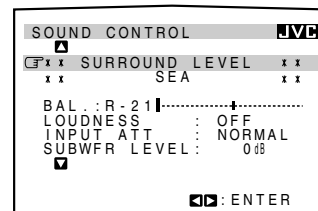

### 5. Press $\Delta$ / $\nabla$ to move $\leftarrow$ to “SURROUND LEVEL,” then press $\triangleleft$ / $\triangleright$ .

The SURROUND LEVEL menu appears.

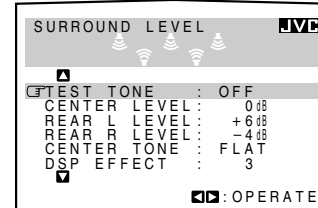

### 6. Press $\Delta$ / $\nabla$ to move $\leftarrow$ to the item you want to set or adjust, then press $\triangleleft$ / $\triangleright$ .

On these adjustment menus, you can do the following:

**For 3D-PHONIC (3D ACTION, 3D DIGITAL, 3D THEATER):**

“DSP EFFECT”: Select the effect level.

**For DAP (LIVE CLUB, DANCE CLUB, HALL, PAVILION):**

“REAR L LEVEL”: Adjust the left rear speaker output level. \*

“REAR R LEVEL”: Adjust the right rear speaker output level. \*

“DSP EFFECT”: Select the effect level.

### For Dolby Pro Logic:

- “TEST TONE”: Output a test tone.
- “CENTER LEVEL”: Adjust the center speaker output level. \*\*
- “REAR L LEVEL”: Adjust the left rear speaker output level. \*
- “REAR R LEVEL”: Adjust the right rear speaker output level. \*
- “CENTER TONE”: Select the center tone level. \*\*

### For Dolby Digital and DTS Digital Surround:

- “TEST TONE”: Output a test tone.
- “CENTER LEVEL”: Adjust the center speaker output level. \*\*
- “REAR L LEVEL”: Adjust the left rear speaker output level. \*
- “REAR R LEVEL”: Adjust the right rear speaker output level. \*
- “CENTER TONE”: Select the center tone level. \*\*

### For JVC Theater Surround:

- “TEST TONE”: Output a test tone.
- “CENTER LEVEL”: Adjust the center speaker output level. \*\*
- “REAR L LEVEL”: Adjust the left rear speaker output level. \*
- “REAR R LEVEL”: Adjust the right rear speaker output level. \*
- “CENTER TONE”: Select the center tone level. \*\*
- “DSP EFFECT”: Select the effect level.

### Notes:

\* Not displayed when “REAR SPK” is set to “NONE” (see page 14).

\*\* Not displayed when “CENTER SPK” is set to “NONE” (see page 14).

7. When you finish, press EXIT repeatedly until the menu disappears from the TV.

### Activating the DVD MULTI Playback Mode

(Also see page 29)

1. Press MENU.

The MAIN MENU appears on the TV.

- Pressing one of the  $\Delta / \nabla / \triangleleft / \triangleright$  buttons also displays the MAIN MENU.

2. Press  $\Delta / \nabla$  to move  $\square$  to “SOURCE.”

3. Press  $\triangleleft / \triangleright$  to select “DVD MULTI.”

4. Press  $\Delta / \nabla$  to move  $\square$  to “SOUND CONTROL,” then press  $\triangleleft / \triangleright$ .

The SOUND CONTROL menu appears.

5. Press  $\Delta / \nabla$  to move  $\square$  to “SURROUND LEVEL,” then press  $\triangleleft / \triangleright$ .

The SURROUND LEVEL menu appears.

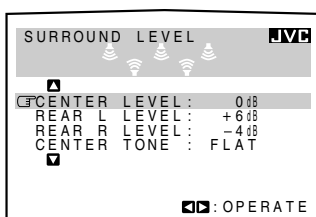

6. Press  $\Delta / \nabla$  to move  $\square$  to the item you want to set or adjust, then press  $\triangleleft / \triangleright$ .

On this adjustment menu, you can do the following:

- “CENTER LEVEL”: Adjust the center speaker output level.
- “REAR L LEVEL”: Adjust the left rear speaker output level.
- “REAR R LEVEL”: Adjust the right rear speaker output level.
- “CENTER TONE”: Select the center tone level.

7. When you finish, press EXIT repeatedly until the menu disappears from the TV.

### Selecting Your Favorite SEA Mode

(Also see page 19)

1. Press MENU.

The MAIN MENU appears on the TV.

- Pressing one of the  $\Delta / \nabla / \triangleleft / \triangleright$  buttons also displays the MAIN MENU.

2. Press  $\Delta / \nabla$  to move  $\square$  to “SOUND CONTROL,” then press  $\triangleleft / \triangleright$ .

The SOUND CONTROL menu appears.

3. Press  $\Delta / \nabla$  to move  $\square$  to “SEA,” then press  $\triangleleft / \triangleright$ .

The SEA menu appears.

4. Press  $\Delta / \nabla$  to move  $\square$  to “SEA MODE.”

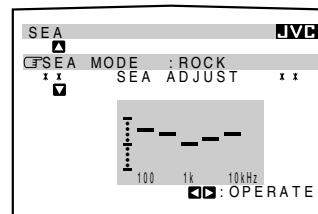

5. Press  $\triangleleft / \triangleright$  to select the SEA mode you want.

6. When you finish, press EXIT repeatedly until the menu disappears from the TV.

### Creating Your Own SEA Mode

(Also see page 19)

1. Press MENU.

The MAIN MENU appears on the TV.

- Pressing one of the  $\Delta / \nabla / \triangleleft / \triangleright$  buttons also displays the MAIN MENU.

2. Press  $\Delta / \nabla$  to move  $\square$  to “SOUND CONTROL,” then press  $\triangleleft / \triangleright$ .

The SOUND CONTROL menu appears.

3. Press  $\Delta / \nabla$  to move  $\square$  to “SEA,” then press  $\triangleleft / \triangleright$ .

The SEA menu appears.

**4. Press  $\Delta$  /  $\nabla$  to move  $\leftarrow$  to “SEA ADJUST.”**

The SEA ADJUST menu appears.

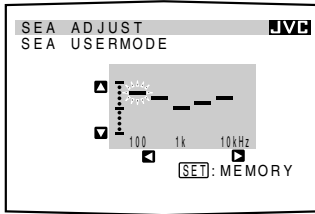

**5. Press  $\Delta$  /  $\nabla$  /  $\leftarrow$  /  $\rightarrow$  to adjust the SEA mode as you want.**

$\leftarrow$  /  $\rightarrow$  : Select the frequency ranges.  
 $\Delta$  /  $\nabla$  : Adjust the frequency levels.

**6. Press SET to store the setting into the SEA USERMODE.**

• If you press EXIT, without pressing SET in this step, you can return to the SEA menu. (The adjustment you have made is active but not stored.)

**7. When you finish, press EXIT repeatedly until the menu disappears from the TV.**

**Setting the Basic Setting Items (Also see pages 12 – 15)**

**1. Press MENU.**

The MAIN MENU appears on the TV.

• Pressing one of the  $\Delta$  /  $\nabla$  /  $\leftarrow$  /  $\rightarrow$  buttons also displays the MAIN MENU.

**2. Press  $\Delta$  /  $\nabla$  to move  $\leftarrow$  to “SETTING,” then press  $\leftarrow$  /  $\rightarrow$ .**

The SETTING 1 or SETTING 2 menu appears.

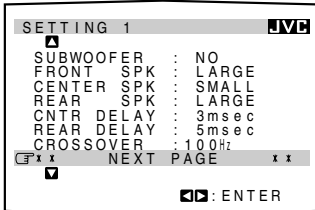

**3. Press  $\Delta$  /  $\nabla$  to move  $\leftarrow$  to the item you want to set or adjust, then press  $\leftarrow$  /  $\rightarrow$ .**

• To go to the SETTING 2 menu, move  $\leftarrow$  to “NEXT PAGE,” then press  $\leftarrow$  /  $\rightarrow$ .  
 • To go back to the SETTING 1 menu, move  $\leftarrow$  to “PREVIOUS PAGE,” then press  $\leftarrow$  /  $\rightarrow$ .

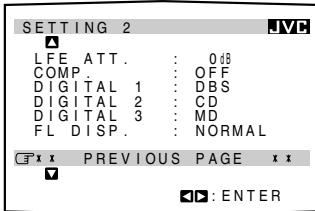

On the SETTING 1 and 2 menus, you can do the following:

- “SUBWOOFER”: Set the subwoofer information (see page 12).
- “FRONT SPK”: Set the front speaker information (see page 14).
- “CENTER SPK”: Set the center speaker information (see page 14).
- “REAR SPK”: Set the rear speaker information (see page 14).
- “CNTR DELAY”: Adjust the delay time of the center speaker output (see page 14). \*
- “REAR DELAY”: Adjust the delay time of the rear speaker output (see page 14). \*\*
- “CROSSOVER”: Set the crossover frequency (see page 15).

“LFE ATT.”:

Set the low frequency effect attenuator level (see page 15).

“COMP.”:

Set the dynamic range compression (see page 15).

“DIGITAL 1/2/3”:

Set the digital input terminal (see page 13).

“FL DISP.”:

Shows the disc text information on the display (see page 13).

**Notes:**

\* Not adjustable when “CENTER SPK” is set to “NONE” (see page 14).

\*\* Not adjustable when “REAR SPK” is set to “NONE” (see page 14).

**4. When you finish, press EXIT repeatedly until the menu disappears from the TV.**

**Operating the Tuner (Also see pages 17 and 18)**

**1. Press MENU.**

The MAIN MENU appears on the TV.

• Pressing one of the  $\Delta$  /  $\nabla$  /  $\leftarrow$  /  $\rightarrow$  buttons also displays the MAIN MENU.

**2. Press  $\Delta$  /  $\nabla$  to move  $\leftarrow$  to “TUNER CONTROL,” then press  $\leftarrow$  /  $\rightarrow$ .**

The TUNER CONTROL menu appears.

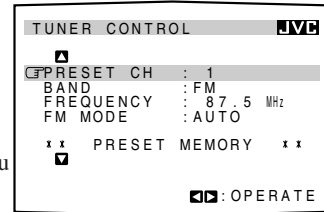

**3. Press  $\Delta$  /  $\nabla$  to move  $\leftarrow$  to the item you want to set or adjust, then press  $\leftarrow$  /  $\rightarrow$ .**

On the TUNER CONTROL menu, you can do the following:

“PRESET CH”:

Select a preset channel station.

“BAND”:

Select the band.

“FREQUENCY”:

Tune in a station manually.

“FM MODE”:

Select the FM reception mode.\*

“PRESET MEMORY”: See “Storing the Preset Stations” on the next page.

**Note:**

\* Not displayed when an AM station is selected.

**4. When you finish, press EXIT repeatedly until the menu disappears from the TV.**

## Storing the Preset Stations (Also see page 17)

### 1. Press MENU.

The MAIN MENU appears on the TV.

- Pressing one of the  $\Delta$  /  $\nabla$  /  $\triangleleft$  /  $\triangleright$  buttons also displays the MAIN MENU.

### 2. Press $\Delta$ / $\nabla$ to move $\leftarrow$ to "TUNER CONTROL," then press $\triangleleft$ / $\triangleright$ .

The TUNER CONTROL menu appears.

### 3. Tune into a station on the TUNER CONTROL menu, referring to "Operating the Tuner" on the previous page.

### 4. Press $\Delta$ / $\nabla$ to move $\leftarrow$ to "PRESET MEMORY," then press $\triangleleft$ / $\triangleright$ .

The PRESET MEMORY menu appears.

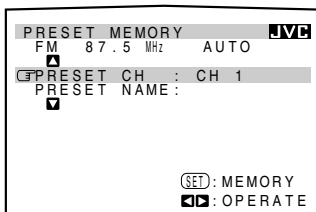

### 5. Press $\triangleleft$ / $\triangleright$ to select a preset station number you want.

### 6. Press SET to store the setting.

### 7. When you finish, press EXIT repeatedly until the menu disappears from the TV.

## Assigning Names to Preset Stations (Also see page 18)

### 1. Press MENU.

The MAIN MENU appears on the TV.

- Pressing one of the  $\Delta$  /  $\nabla$  /  $\triangleleft$  /  $\triangleright$  buttons also displays the MAIN MENU.

### 2. Press $\Delta$ / $\nabla$ to move $\leftarrow$ to "TUNER CONTROL," then press $\triangleleft$ / $\triangleright$ .

The TUNER CONTROL menu appears.

### 3. Press $\Delta$ / $\nabla$ to move $\leftarrow$ to "PRESET CH."

### 4. Press $\triangleleft$ / $\triangleright$ to select a preset station.

### 5. Press $\Delta$ / $\nabla$ to move $\leftarrow$ to "PRESET MEMORY," then press $\triangleleft$ / $\triangleright$ .

The PRESET MEMORY menu appears.

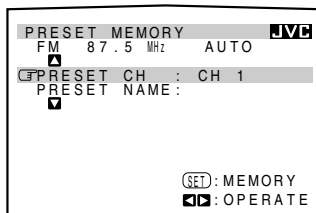

### 6. Press $\Delta$ / $\nabla$ to move $\leftarrow$ to "PRESET NAME," then press SET.

The character entry screen appears.

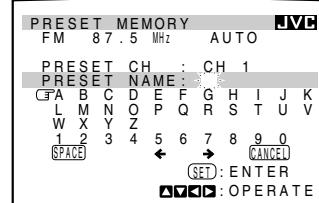

### 7. Press $\Delta$ / $\nabla$ / $\triangleleft$ / $\triangleright$ to move $\leftarrow$ in front of a character you want.

You can also select the following:

- SPACE** : To enter space
- CANCEL** : To erase the character
- $\leftarrow$  /  $\rightarrow$**  : To go back to the previous character position or go to the next character position

### 8. Press SET to enter the selected character.

### 9. Repeat steps 7 and 8 to enter up to four characters.

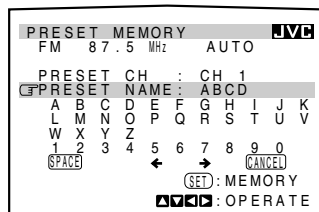

### 10. Press $\Delta$ / $\nabla$ / $\triangleleft$ / $\triangleright$ to move $\leftarrow$ to "PRESET NAME," then press SET to store the setting.

The TUNER CONTROL menu appears again.

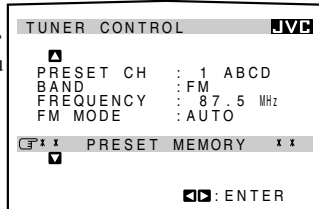

### 11. When you finish, press EXIT repeatedly until the menu disappears from the TV.

To use this remote control system, you need to connect JVC audio components through the COMPU LINK-3 (SYNCHRO) jacks (see below) in addition to the connections using cables with RCA pin plugs (see pages 5 and 6).

- Make sure that the AC power cords of these components are unplugged before connection. Plug the AC power cords only after all connections are complete.

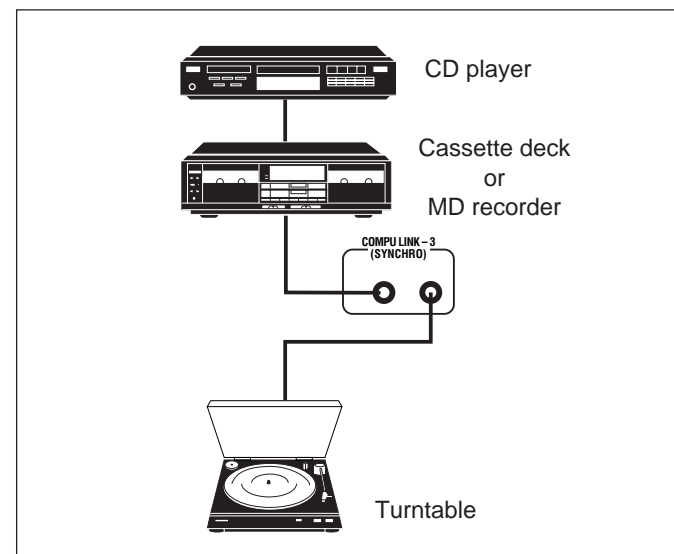

#### **Notes:**

- If your audio component has two COMPU LINK-3 (SYNCHRO) jacks, you can use either one. If it has only one COMPU LINK-3 (SYNCHRO) jack, connect it so that it is the last item in the series of components. (For example, the turntable or CD player in the diagram above.)
- To operate the cassette deck or MD recorder using the COMPU LINK remote control system, set the source name correctly. (See page 12.)
- Refer also to the manuals supplied with your audio components.

This remote control system allows you to use four functions listed below.

#### **Remote Control through the Remote Sensor on the Receiver**

You can control the connected audio components through the remote sensor on the receiver using this remote control. Aim the remote control directly at the remote sensor on the receiver. For details, see pages 44 and 45.

#### **Automatic Source Selection**

When you press the play (▶) button on a connected component or on its own remote control, the receiver automatically turns on and changes the source to the component. On the other hand, if you select a new source on the receiver or on the remote control, the selected component begins playing immediately.

In both cases, the previously selected source continues playing without sound for a few seconds.

#### **Automatic Power On/Off (Standby): only possible with the COMPU LINK-3 connection**

Both the CD player and cassette deck (or MD recorder) turn on and off (standby) along with the receiver.

When you turn on the receiver, the CD player or cassette deck (or MD recorder) will turn on automatically, depending on which component has been previously selected.

When you turn off the receiver, both the CD player and cassette deck (or MD recorder) will turn off (standby).

#### **Synchronized Recording**

Synchronized recording means the cassette deck (or MD recorder) starts recording as soon as a CD or a record begins playing.

To use synchronized recording, follow these steps:

1. Put a tape in the cassette deck (or an MD in the MD recorder), and a disc in the CD player (or a record on the turntable).
2. Press the record (●) button and the pause (II) button on the cassette deck (or MD recorder) at the same time.

This puts the cassette deck (or MD recorder) into recording pause.

If you do not press the record (●) button and pause (II) button at the same time, the synchronized recording feature will not operate.

3. Press the play (▶) button on the CD player or on the turntable.

The source changes on the receiver, and as soon as play starts, the cassette deck (or MD recorder) starts recording. When the play ends, the cassette deck (or MD recorder) enters recording pause, and stops about 4 seconds later.

#### **Notes:**

- During synchronized recording, the selected source cannot be changed.
- If the power of any component is shut off during synchronized recording, the COMPU LINK remote control system may not operate properly. In this case, you must start again from the beginning.

## CONNECTIONS:

To use this remote control system, you need to connect the CD player and/or MD recorder you want to operate, following the procedures below.

1. If you have already plugged your CD player, MD recorder, and this receiver into the AC outlets, unplug their AC power cords first.
2. Connect your CD player, MD recorder, and this receiver as follows, through the COMPU LINK-3 (SYNCHRO) jacks and TEXT COMPU LINK jacks.

- 1) **COMPU LINK-3 (SYNCHRO) jacks:** Use the cables with the monaural mini-plugs (not supplied with this receiver).

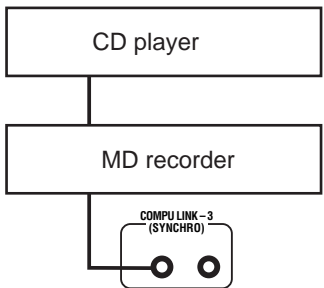

- 2) **TEXT COMPU LINK jacks:** Use the cables with the stereo mini-plugs (not supplied with this receiver).

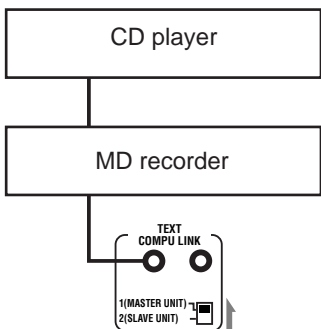

## IMPORTANT:

Set the Master/Slave Selector on the rear to "1(MASTER UNIT)."  
• "2(SLAVE UNIT)" is just for the serviceman's use. The TEXT COMPU LINK remote control system does not function with the selector set to "2(SLAVE UNIT)."

3. Connect your CD player, MD recorder and this receiver, using the cables with RCA pin plugs (see pages 5 and 6).
4. Plug the AC power cords of these components above into the AC outlets.
5. When turning on these components for the first time, turn on the connected components first,

## FUNCTIONS:

This remote control system allows you to use the functions listed below.

### ***Displaying the Disc Information on the TV screen***

Disc information such as its performer and disc title (and track titles only when a CD Text is selected) is shown on the TV screen.

### ***Disc Search: Only for CD Player***

This remote control system can allow you to search discs by the performer, disc title, and music genre.  
With this disc search, you can easily find the disc you want to play.

### ***Disc Title Input***

If your CD player or MD recorder has the disc memory function, you can input the following information about the normal audio CDs or MDs on the TV screen.

- For CDs: Performer, disc title, and music genre
- For MDs: Disc title and song titles

### ***\* What is a CD Text?***

*In a CD Text, some information about the disc (its disc title, performer, composer, arranger, etc.) is recorded.*

### ***Notes:***

- If your audio component has two COMPU LINK-3 (SYNCHRO) jacks, you can use either one. If it has only one COMPU LINK-3 (SYNCHRO) jack, connect it so that it is the last item in the series of components. (For example, the CD player in the diagram to the left.)
- If your audio component has two TEXT COMPU LINK jacks, you can use either one. If it has only one TEXT COMPU LINK jack, connect it so that it is the last item in the series of components. (For example, the CD player in the diagram to the left.)
- "TEXT COMPU LINK SOURCE NOT CONNECTED" appears on the display in the following cases:
  - When the connections explained to the left are not correctly done.
  - When you try to use the TEXT COMPU LINK function a few seconds after you turn on the connected equipment. This is not a malfunction of the units.
- Refer also to the manuals supplied with your CD player or MD recorder.

## IMPORTANT:

If you turn on the receiver before turning on the other components after connecting the components, the TEXT COMPU LINK remote control system does not work correctly.

If this happens:

1. Turn off all the components including this receiver.
2. Turn on the connected components.
3. Turn on this receiver.

# OPERATIONS

To use this remote control system, you need to connect the TV to the MONITOR OUT jack on the rear panel (see page 7), and set the TV's input mode to the proper position to which the receiver is connected. **Make sure you have connected the CD player or MD recorder equipped with the TEXT COMPU LINK remote control system. If not, you cannot use the following functions.**

## On-Screen Operation buttons (on the remote control)

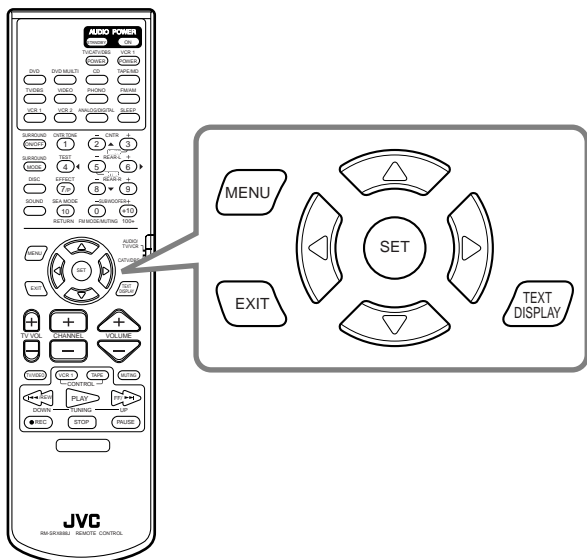

- ① Source name: CD or MD
- ② Select **▲** or **▼**, then press SET to change the disc.
- ③ Track numbers and track titles.
  - The current playing (selected) track is indicated in yellow.
  - When you move **⇐** to a track number, you can change the track information by pressing **</>**. Each time you press the button, track information alternates between its track title and its performer. (You can also start playing the track by pressing SET.)
- ④ Select this (move **⇐** in front), then press SET to go to the DISC SEARCH screen (see page 39).
- ⑤ Select this (move **⇐** in front), then press SET to go to the TITLE INPUT screen (see page 40).
- ⑥ This appears only when a CD Text is selected.
- ⑦ Disc information such as the disc title, performer, and music genre.
  - When this is selected (**⇐** in front), you can change the disc information by pressing **</>**. Each time you press the button, disc information (see “Note on ⑦”) changes.
- ⑧ Select **▲** or **▼**, then press SET to change the track.
- ⑨ Usable buttons and their functions for the current selection.
  - Indication here will be changed according to what is currently selected (**⇐** in front) on the screen. See “Note on ⑨.”

### Note on ⑦:

The following information will appear on the display:

- Disc title
- Performer
- Genre
- Song writer
- Composer
- Arranger
- Message

Only recorded information will be shown. If there is no data, “NO DATA” will appear.

### Note on ⑨:

For example, the SET button will be used to start play (PLAY), to go to the next screen (ENTER), and to determine the selection (ENTER).

### To exit from the Disc information screen:

Press EXIT.

### Notes:

- The on-screen display will disappear in the following case:
  - if no operation is done for about 10 minutes.
  - if you do any operation other than explained in this section.
- To control the MD recorder using the TEXT COMPU LINK remote control system, you have to change the source name shown on the display from “TAPE” to “MD.” (See page 12.)
- Some special characters and marks cannot be displayed correctly.

## Showing the Disc Information on the TV Screen

Press **TEXT DISPLAY** while “CD” or “MD” is selected as the source.

The Disc Information screen appears on the TV.

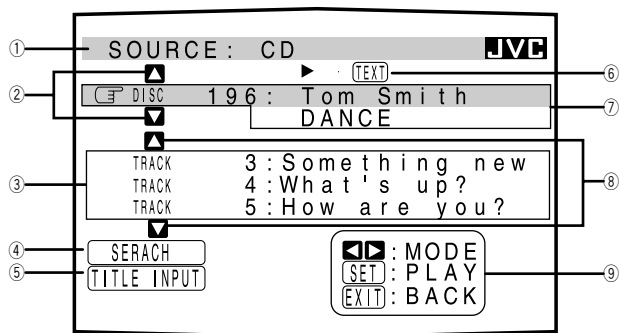



## ■ Searching for a Disc (Only for the CD player)

### Search for a disc by its performer:

1. Press TEXT DISPLAY while “CD” is selected as the source.

The Disc Information screen appears on the TV.

2. Press  $\Delta / \nabla$  to move  $\leftarrow$  to “SEARCH,” then press SET.

The DISC SEARCH screen appears.

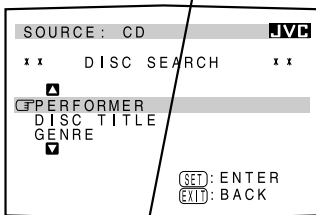

3. Press  $\Delta / \nabla$  to move  $\leftarrow$  to “PERFORMER”, then press SET.

The PERFORMER SEARCH screen appears.

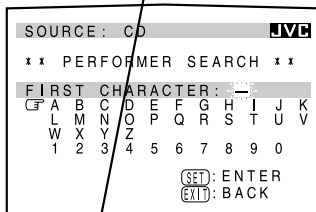

4. Press  $\Delta / \nabla / \triangleleft / \triangleright$  to move  $\leftarrow$  in front of the first character of the performer you want to search, then press SET.

To correct the incorrect entry, press  $\Delta / \nabla / \triangleleft / \triangleright$  to move  $\leftarrow$  in front of the correct character, then press SET.

### Note:

Symbols such as @, # or \$ cannot be available for search.

5. Press SET again.

Disc search starts, then the SEARCH RESULT screen, showing the performers, appears.

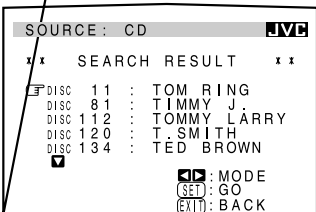

6. On the SEARCH RESULT screen, you can do the following:

- **Changing the indication of the disc information:** Press  $\Delta / \nabla$  to move  $\leftarrow$  to a searched disc, then press  $\triangleleft / \triangleright$ . Each time you press  $\triangleleft / \triangleright$ , the disc information alternates between its performer and its disc title.
- **Starting a disc play and going to the Disc Information screen (see page 38):** Press  $\Delta / \nabla$  to move  $\leftarrow$  to a searched disc, then press SET.
- **Showing unseen disc information (if more than 5 discs are listed as a result of the search):** Press  $\Delta / \nabla$  until they appear.
- **Going back to the PERFORMER SEARCH screen:** Press EXIT.

### Search for a disc by its disc title:

1. Press TEXT DISPLAY while “CD” is selected as the source.

The Disc Information screen appears on the TV.

2. Press  $\Delta / \nabla$  to move  $\leftarrow$  to “SEARCH,” then press SET.

The DISC SEARCH screen appears.

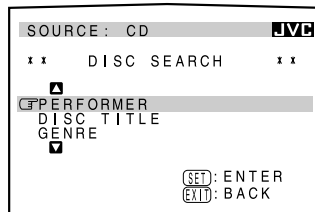

3. Press  $\Delta / \nabla$  to move  $\leftarrow$  to “DISC TITLE”, then press SET.

The DISC TITLE SEARCH screen appears.

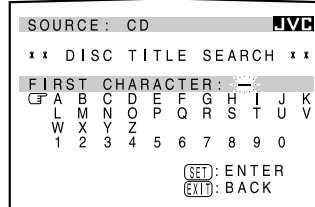

4. Press  $\Delta / \nabla / \triangleleft / \triangleright$  to move  $\leftarrow$  in front of the first character of the disc title you want to search, then press SET.

To correct the incorrect entry, press  $\Delta / \nabla / \triangleleft / \triangleright$  to move  $\leftarrow$  in front of the correct character, then press SET.

### Note:

Symbols such as @, # or \$ cannot be available for search.

5. Press SET again.

Disc search starts, then the SEARCH RESULT screen, showing the disc titles, appears.

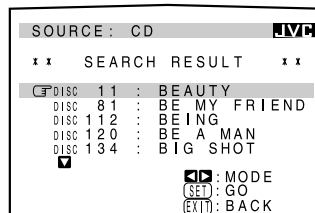

6. On the SEARCH RESULT screen, you can do the following:

- **Changing the indication of the disc information:** Press  $\Delta / \nabla$  to move  $\leftarrow$  to a searched disc, then press  $\triangleleft / \triangleright$ . Each time you press  $\triangleleft / \triangleright$ , the disc information alternates between its disc title and its performer.
- **Starting a disc play and going to the Disc Information screen (see page 38):** Press  $\Delta / \nabla$  to move  $\leftarrow$  to a searched disc, then press SET.
- **Showing unseen disc information (if more than 5 discs are listed as a result of the search):** Press  $\Delta / \nabla$  until they appear.
- **Going back to the DISC TITLE SEARCH screen:** Press EXIT.

## Search for a disc by its genre:

1. Press **TEXT DISPLAY** while “CD” is selected as the source.

The Disc Information screen appears on the TV.

2. Press  $\Delta / \nabla$  to move  $\text{F}$  to “SEARCH,” then press **SET**.

The DISC SEARCH screen appears.

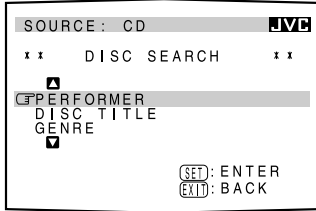

3. Press  $\Delta / \nabla$  to move  $\text{F}$  to “GENRE”, then press **SET**.

The GENRE SEARCH screen appears.

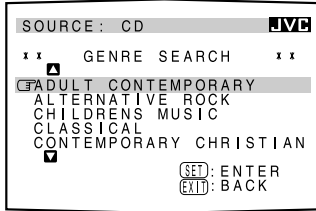

4. Press  $\Delta / \nabla$  to move  $\text{F}$  to the genre you want to search, then press **SET**.

To show the unseen genres, press  $\Delta / \nabla$  until they appear.

Disc search starts, then the SEARCH RESULT screen, showing the disc titles, appears.

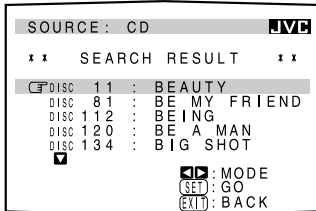

5. On the SEARCH RESULT screen, you can do the following:

- **Changing the indication of the disc information:** Press  $\Delta / \nabla$  to move  $\text{F}$  to a searched disc, then press  $\leftarrow / \rightarrow$ . Each time you press  $\leftarrow / \rightarrow$ , the disc information alternates between its disc title and its performer.
- **Starting a disc play and going to the Disc Information screen (see page 38):** Press  $\Delta / \nabla$  to move  $\text{F}$  to a searched disc, then press **SET**.
- **Showing unseen disc information (if more than 5 discs are listed as a result of the search):** Press  $\Delta / \nabla$  until they appear.
- **Going back to the GENRE SEARCH screen:** Press **EXIT**.

## Entering the Disc Information

### For the CD Player with the disc memory function:

You can use the disc memory function through this receiver. The disc information (its performer, disc title, and music genre) of normal audio CDs will be stored into the memory built in the CD player.

For the disc memory function, refer to the manual supplied with your CD player.

- The performer, disc title, and music genre information are usually recorded in a CD Text. However, if a CD Text has no genre information recorded in the disc itself, you can input its music genre by yourself.

### Note:

You can enter the TITLE INPUT screens for a CD Text and input its titles. However, you cannot store the titles you have input for a CD Text.

**Example: Entering the following information for Disc 1**  
Performer: “MICHAEL”  
Disc title: “MY FAVORITE”

1. Press **TEXT DISPLAY** while “CD” is selected as the source.

The Disc Information screen appears on the TV.

2. Press  $\Delta / \nabla$  to move  $\text{F}$  to “TITLE INPUT,” then press **SET**.

The TITLE INPUT: PERFORMER screen appears.

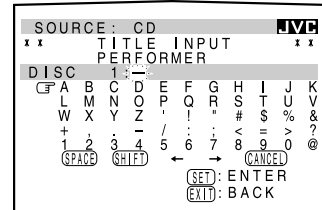

3. Press  $\Delta / \nabla / \leftarrow / \rightarrow$  to move  $\text{F}$  in front of a character you want, then press **SET** to enter the character.

- If the current CD is a CD Text, go to step 5 without entering the performer.

To use the lower case letters, press  $\Delta / \nabla / \leftarrow / \rightarrow$  to move  $\text{F}$  to **[SHIFT]**, then press **SET**.

To use the upper case letters again, press  $\Delta / \nabla / \leftarrow / \rightarrow$  to move  $\text{F}$  to **[SHIFT]**, then press **SET**.

4. Repeat step 3 until you finish putting a performer name (up to 32 characters).

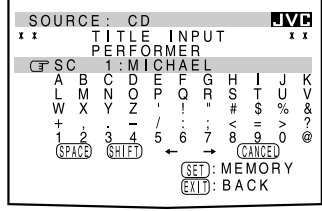

To insert a space, press  $\Delta / \nabla$  /  $\triangleleft / \triangleright$  to move  $\text{C}$  to (SPACE), then press SET.

To correct an incorrect character:

- 1) Press  $\Delta / \nabla$  /  $\triangleleft / \triangleright$  to move  $\text{C}$  to  $\leftarrow$  or  $\rightarrow$ , then press SET until the incorrect character is selected.
- 2) Press  $\Delta / \nabla$  /  $\triangleleft / \triangleright$  to move  $\text{C}$  to (CANCEL), then press SET to erase the character.
- 3) Press  $\Delta / \nabla$  /  $\triangleleft / \triangleright$  to move  $\text{C}$  in front of the correct character, then press SET to enter a correct character.

5. Press  $\Delta / \nabla$  /  $\triangleleft / \triangleright$  to move  $\text{C}$  to "DISC 1: MICHAEL (in this example)," then press SET.

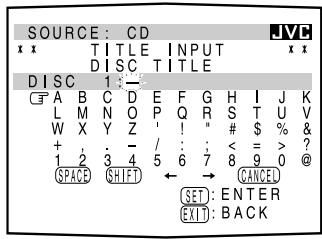

The TITLE INPUT: DISC TITLE screen appears.

6. Enter the disc title, referring to steps 3 and 4.

- If the current CD is a CD Text, go to the next step without entering the disc title.

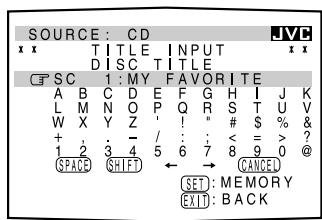

7. Press  $\Delta / \nabla$  /  $\triangleleft / \triangleright$  to move  $\text{C}$  to "DISC 1: MY FAVORITE (in this example)," then press SET.

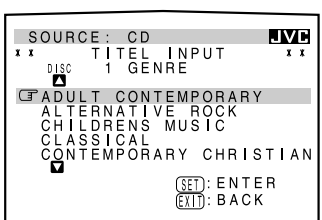

The TITLE INPUT: DISC 1 GENRE screen appears.

8. Press  $\Delta / \nabla$  to move  $\text{C}$  to the genre you want, then press SET.

The Disc Information screen appears again.

To show the unseen genres, press  $\Delta / \nabla$  until they appear.

**For the MD recorder:**

You can write the disc information (disc title and song titles) into the disc. You can only write the song title for the song currently selected.

- If you have the CD-MD combination deck, you can also enter the disc information (its performer, disc title, and its music genre) of normal audio CDs into the memory built in the CD-MD combination deck. (To do this, follow the procedure of "For the CD Player with the disc memory function" to the left.)
- If you change the disc or song title with more than 32 characters, the characters following the 32nd will be erased from the title.

1. Press TEXT DISPLAY while "MD" is selected as the source.

The Disc Information screen appears on the TV.

2. Press  $\Delta / \nabla$  to move  $\text{C}$  to "TITLE INPUT," then press SET.

The DISC TITLE INPUT screen appears.

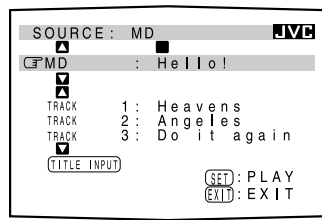

3. Enter the title, referring to steps 3 and 4 of "For the CD Player with the disc memory function" to the left.

- You can enter up to 32 characters for the disc title.

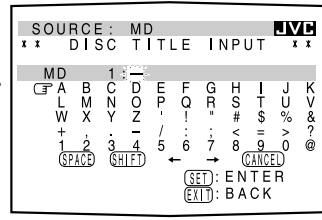

4. Press  $\Delta / \nabla$  /  $\triangleleft / \triangleright$  to move  $\text{C}$  to the disc title you have just entered, then press SET.

The disc title is stored into the memory, and the SONG TITLE INPUT screen for the currently selected song appears.

- You can enter a song title for the song currently selected (indicated in yellow on the TV screen).

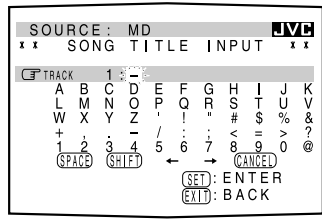

5. Enter the song title, referring to steps 3 and 4 of "For the CD Player with the disc memory function" to the left.

- You can enter up to 32 characters for the song title.

6. Press  $\Delta / \nabla$  /  $\triangleleft / \triangleright$  to move  $\text{C}$  to the song title you have just entered, then press SET.

The song title is stored into the memory, and the Disc Information screen appears again.

To use this remote control system, you need to connect the video components you want to operate, follow the diagrams below and the procedure on the next page.

**CONNECTIONS 1:**

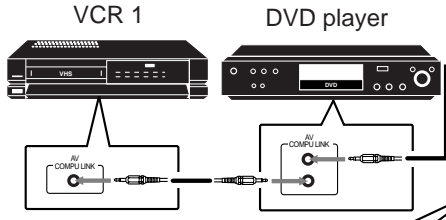

**IMPORTANT:**  
Connect to the terminal indicated in the illustration.  
**DO NOT** connect to the TV terminal.

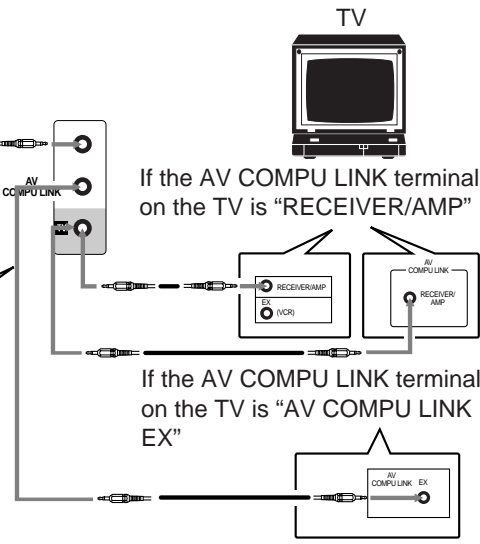

**CAUTION:**  
The AV COMPU LINK remote control system cannot control the DBS tuner connected to the TV SOUND/DBS jacks, and video components connected to the VIDEO and VCR 2 jacks on the receiver.

**Notes:**

- When connecting only the VCR 1 or DVD player to this receiver, connect it directly to the receiver using cable with the monaural mini-plugs.
- Refer also to the manual supplied with your video components.

**CONNECTIONS 2:**

**CASE1:** If the components are equipped with the S-video terminals

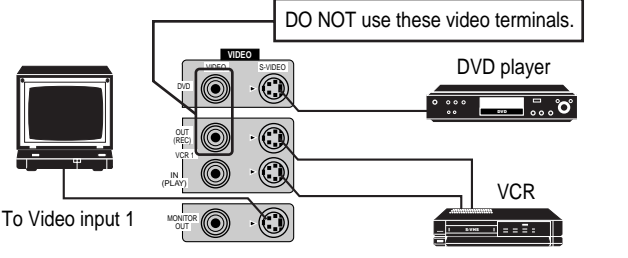

**CASE2:** If the components are not equipped with the S-video terminals

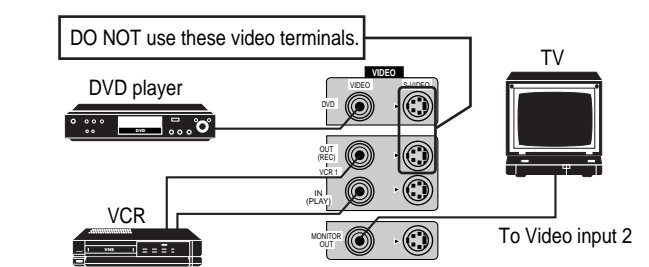

**CASE3:** If only the VCR is equipped with the S-video terminal

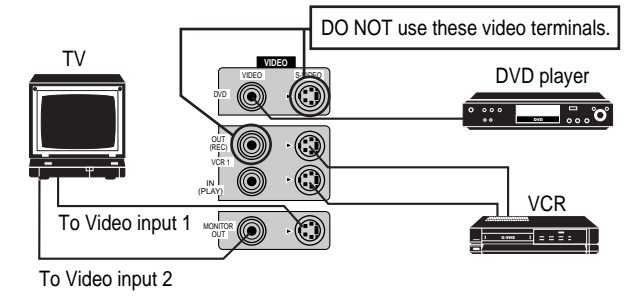

**CASE4:** If only the DVD player is equipped with the S-video terminal

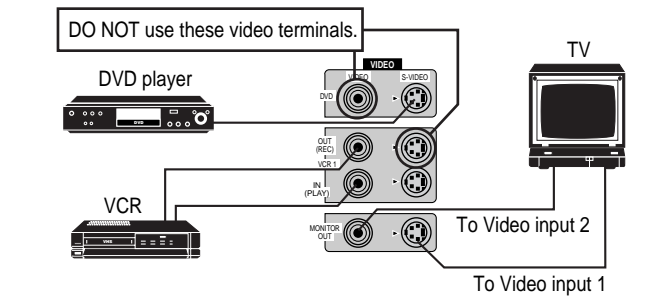

1. **If you have already plugged your VCR 1 (VCR connected to the VCR 1 jacks), DVD player, TV, and this receiver into the AC outlets, unplug their AC power cords first.**
2. **Connect your VCR 1, DVD player, TV, and this receiver as follows, using the cables with the monaural mini-plugs (not supplied).**
  - See “CONNECTIONS 1” on the previous page.
3. **Connect the audio input/output jacks on VCR 1, DVD player, TV, and this receiver using the cables with RCA pin plug**
  - See pages 6 and 7.
4. **Connect the video input/output jacks on VCR 1, DVD player, TV, and this receiver, using the cables with RCA pin plug or with S-video plug.**
  - See “CONNECTIONS 2” on the previous page.
5. **Plug the AC power cords of the components into the AC outlets.**
6. **When turning on the TV for the first time after the AV COMPU LINK connection, turn the TV volume to the minimum using the TV volume control on the TV.**
7. **Turn on the other connected components first, then turn on this receiver.**
  - When turning on the VCR 1, use the remote control supplied with this receiver (press VCR 1 POWER).

The AV COMPU LINK remote control system allows you to use the five basic functions listed below.

### **Remote Control of the TV, DVD player, and VCR Using This Remote Control**

See page 45 for details.

#### **For the DVD player and the VCR:**

- Aim the remote control directly at the remote sensor on each component.

#### **For the TV having AV COMPU LINK terminal “RECEIVER/AMP”:**

- Aim the remote control directly at the remote sensor on the receiver when operating the TV.

#### **For the TV having AV COMPU LINK terminal “AV COMPU LINK EX”:**

- Aim the remote control directly at the remote sensor on the TV when operating the TV.

### **One-Touch Video Play**

Simply by inserting a video cassette without its safety tab into the VCR 1 (the VCR connected to the VCR 1 jacks), you can enjoy the video playback without setting other switches manually. The receiver automatically turns on and changes the source to “VCR 1.” The TV automatically turns on and changes the input mode to the position so that you can view the playback picture. When you insert a video cassette with its safety tab, press the play

### **One-Touch DVD Play**

Simply by starting playback on the DVD player, you can enjoy the DVD playback without setting other switches manually.

- When the DVD player is connected through the analog input jacks on this receiver (and analog input is selected), the receiver automatically turns on and changes the source to “DVD” or “DVD MULTI.”
- When the DVD player is connected through the digital input terminal on this receiver (and digital input is selected), the receiver automatically turns on and changes the source to “DVD DIGITAL.”

The TV automatically turns on and changes the input mode to the position so that you can view the playback picture.

### **Automatic Selection of TV's Input Mode**

- When you select “TV SOUND” as the source to play on the receiver, the TV automatically changes the input mode to the TV tuner so that you can watch TV.
- When you select “VCR 2,” as the source to play on the receiver, the TV automatically changes the input mode to the Video Input 2 so that you can watch the playback picture.
- When you select “DVD” (or “DVD DIGITAL”), “DVD MULTI,” “VCR 1,” “VIDEO” or “DBS” (or “DBS DIGITAL”) as the source to play on the receiver, the TV automatically changes the input mode to the appropriate position (either Video Input 1 or Video Input 2) so that you can view the playback picture.

#### **Note:**

*When you select “TV SOUND” as the source on the receiver, you cannot see the menu on the TV screen since the AV COMPU LINK remote control system automatically changes the TV's input mode to the TV tuner.*

*If you do not mind stopping listening to the TV sounds, you can then show the on-screen displays after changing the TV's input mode to the appropriate position (either Video Input 1 or Video Input 2) the receiver is connected to.*

### **Automatic Power On/Off**

The TV, VCR 1 (the VCR connected to the VCR 1 jacks), and DVD player turn on and off along with the receiver.

When you turn on the receiver;

- If the previously selected source is “VCR 1,” the TV and VCR 1 will turn on automatically.
- If the previously selected source is “VIDEO,” “VCR 2,” “TV SOUND” or “DBS” (or “DBS DIGITAL”), only the TV will turn on automatically.
- If the previously selected source is “DVD” (or “DVD DIGITAL”) or “DVD MULTI,” the TV and DVD player will turn on automatically.

When you turn off the receiver, the TV, VCR 1 and the DVD player will turn off.

#### **Note:**

*If you turn off the receiver while recording on the VCR 1, the VCR 1 will not turn off, but continue recording.*

## IMPORTANT:

To operate JVC's audio components using this remote control:

- You need to connect JVC audio components through the COMPU LINK-3 (SYNCHRO) jacks (see page 36) in addition to the connections using cables with RCA pin plugs (see pages 5 and 6).
- Aim the remote control directly at the remote sensor on the receiver.
- If you use the buttons on the front panel or the menu function to choose a source, the remote control will not operate that source. To operate a source with the remote control, the source must be selected using source selecting buttons on the remote control.
- To operate the cassette deck or MD recorder using the COMPU LINK remote control system, set the source name correctly. (See page 12.)
- Refer also to the manuals supplied with your components.

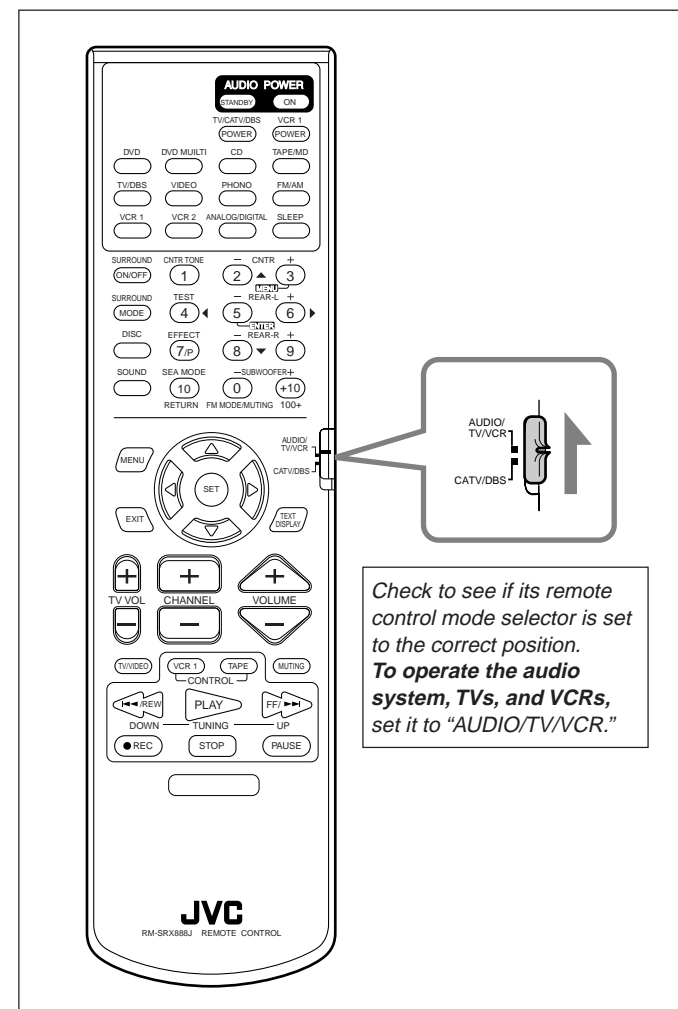

Check to see if its remote control mode selector is set to the correct position.  
**To operate the audio system, TVs, and VCRs, set it to "AUDIO/TV/VCR."**

## Sound control section (Amplifier)

You can always perform the following operations (with the remote control mode selector set to "AUDIO/TV/VCR"):

- SURROUND ON/OFF:** Turns on or off the Surround modes — Dolby Pro Logic, Dolby Digital, and DTS Digital Surround.
- SURROUND MODE:** Selects the DSP modes.

After pressing SOUND (with the remote control mode selector set to "AUDIO/TV/VCR"), you can perform the following operations:

- SEA MODE:** Changes the SEA modes.
- SUBWOOFER - / +:** Adjusts the subwoofer output level.
- CNTR - / +:** Adjusts the center speaker output level.
- REAR•L - / +:** Adjusts the left rear speaker output level.
- REAR•R - / +:** Adjusts the right rear speaker output level.
- EFFECT:** Selects the effect level.
- TEST:** Turns on or off the test tone output.
- CNTR TONE:** Selects the center tone.

### Note:

After adjusting sounds, press the corresponding source selecting button or DISC to operate your target source by using the 10 keys; otherwise, the 10 keys cannot be used for operating your target source.

## CD player

After pressing CD (with the remote control mode selector set to "AUDIO/TV/VCR"), you can perform the following operations on the CD player:

- PLAY:** Starts playing.
- ⏮:** Returns to the beginning of the current (or previous) track.
- ⏭:** Skips to the beginning of the next track.
- STOP:** Stops playing.
- PAUSE:** Pauses playing. To release it, press PLAY.
- 1 - 10, +10:** Selects a track number directly.
  - For track number 5, press 5.
  - For track number 15, press +10, then 5.
  - For track number 20, press +10, then 10.
  - For track number 30, press +10, +10, then 10.

## CD player-changer

After pressing DISC (with the remote control mode selector set to "AUDIO/TV/VCR"), you can perform the following operations on a CD player-changer:

- PLAY:** Starts playing.
- ⏮:** Returns to the beginning of the current (or previous) track.
- ⏭:** Skips to the beginning of the next track.
- STOP:** Stops playing.
- PAUSE:** Pauses playing. To release it, press PLAY.
- 1 - 6, 7/P:** Selects the number of a disc installed in a CD player-changer.

After pressing CD (with the remote control mode selector set to "AUDIO/TV/VCR"), you can perform the following operations on the CD player-changer:

- 1 - 10, +10:** Selects a track number directly.
  - For track number 5, press 5.
  - For track number 15, press +10, then 5.

## Tuner

After pressing FM/AM (with the remote control mode selector set to "AUDIO/TV/VCR"), you can perform the following operations:

- FM/AM:** Alternates between FM and AM.
- 1 - 10, +10:** Selects a preset channel number directly.
  - For channel number 5, press 5.
  - For channel number 15, press +10, then 5.
  - For channel number 20, press +10, then 10.
- TUNING UP/TUNING DOWN:** Tunes into stations.

- FM MODE/MUTING:** Changes the FM reception mode.



This remote control supplied with the receiver can transmit control signals for other manufacturers' VCRs, TVs, CATV converters and DBS tuners. By changing the transmittable signals from preset ones to the other manufacturers', you can operate the other manufacturer's components using this remote control.

When operating the other manufacturers' components, refer also to the manuals supplied with them. To operate these components with the remote control, first you need to set the manufacturer's code each for VCR, TV, CATV converters, and DBS tuner.

## To change the transmittable signals for operating another manufacturer's TV

1. Set the remote control mode to "AUDIO/TV/VCR."
2. Press and hold TV/CATV/DBS POWER.
3. Press TV/DBS.
4. Enter manufacturer's code (three digits) using buttons 1 – 9, and 0.

See the list on pages 48 and 49 to find the code.

Examples: For a JVC product, press 0, 5, then 3.

For a Hitachi product, press 0, 5, then 6.

5. Release TV/CATV/DBS POWER.

The following buttons can be used for operating the TV (with the remote control mode selector set to "AUDIO/TV/VCR"):

TV/CATV/DBS POWER:

Turns on and off the TV.

TV VOL +/-: Adjusts the volume.

TV/VIDEO: Sets the input mode (either TV or VIDEO).

After pressing TV/DBS (with the remote control mode selector set to "AUDIO/TV/VCR"), you can perform the following operations on a TV:

CHANNEL +/-: Changes the channels.

1 – 10, 0, 100+ (+10): Selects the channels. 100+ (+10) button will function as the ENTER button if your TV requires pressing ENTER after selecting a channel number.

### Note:

Refer to the manual supplied with your TV.

6. Try to operate your TV by pressing TV/CATV/DBS POWER.

When your TV turns on or off, you have entered the correct code.

If there are more than one code listed for your brand of TV, try each one until the correct one is entered.

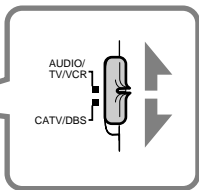
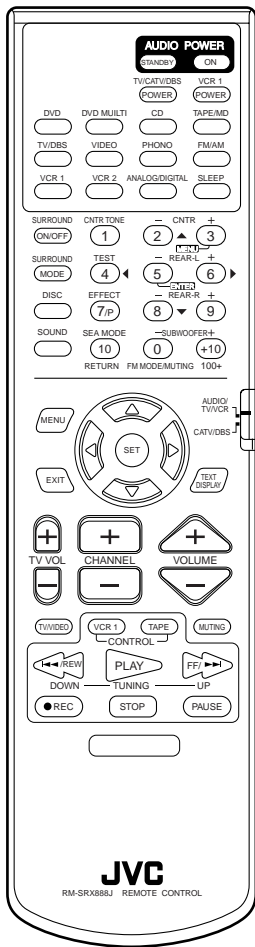

Check to see if its remote control mode selector is set to the correct position.

To operate the audio system, TVs, and VCRs, set it to "AUDIO/TV/VCR."

To operate the CATV converter and DBS tuner, set it to "CATV/DBS."



## To change the transmittable signals for operating a CATV converter or DBS tuner

1. Set the remote control mode to “CATV/DBS.”
2. Press and hold TV/CATV/DBS POWER.
3. Press TV/DBS.
4. Enter manufacturer’s code (three digits) using buttons 1–9, and 0.

See the list on page 49 to find the code.

Examples: For a JVC product, press 7, 7, then 5.

For a Pioneer product, press 1, 4, then 4.

5. Release TV/CATV/DBS POWER.

After setting the remote control mode selector to “CATV/DBS,” you can perform the following operations on the CATV convertor or on the DBS tuner:

TV/CATV/DBS POWER: Turns on and off the CATV converter or DBS tuner.

CHANNEL +/-: Changes the channels.

1 – 10, 0, 100+ (+10): Selects the channel.  
100+ (+10) button will function as the ENTER button if your equipment requires pressing ENTER after selecting a channel number.

### **Note:**

Refer to the manual supplied with your CATV converter or DBS tuner.

6. Try to operate your CATV converter or DBS tuner by pressing TV/CATV/DBS POWER.

When your CATV converter or DBS tuner turns on or off, you have entered the correct code.

If there are more than one code listed for your brand of CATV converter or DBS tuner, try each one until the correct one is entered.

## To change the transmittable signals for operating another manufacturer’s VCR

1. Set the remote control mode to “AUDIO/TV/VCR.”
2. Press and hold VCR 1 POWER.
3. Press VCR 1.
4. Enter manufacturer’s code (three digits) using buttons 1–9, and 0.

See the list on pages 50 and 51 to find the code.

Examples: For a JVC product, press 0, 0, then 8.

For a Funai product, press 0, 0, then 0.

5. Release VCR 1 POWER.

Following button can be used for operating the VCR (with the remote control mode selector set to “AUDIO/TV/VCR”):

VCR 1 POWER Turns on and off the VCR.

After pressing VCR 1 or VCR 1 CONTROL (with the remote control mode selector set to “AUDIO/TV/VCR”), you can perform the following operations on the VCR:

CHANNEL +/- Changes the TV channels on the VCR.

1 – 10, 0, 100+ (+10): Selects the TV channels.  
100+ (+10) button will function as the ENTER button if your VCR requires pressing ENTER after selecting a channel number.

PLAY: Starts playback.

◀◀: Rewinds a video tape.

▶▶: Fast winds a video tape.

STOP: Stops operation.

PAUSE: Pauses.

● REC: Starts recording or enters recording pause.

### **Notes:**

- Refer to the manual supplied with your VCR.
- You can use either VCR 1 button or the VCR 1 CONTROL button to activate the buttons listed above. If you press VCR 1, the playing source also changes. On the other hand, if you press VCR 1 CONTROL, the playing source does not change.

6. Try to operate your VCR by pressing VCR 1 POWER.

When your VCR turns on or off, you have entered the correct code.

If there are more than one code listed for your brand of VCR, try each one until the correct one is entered.

## Manufacturers' codes for TV

Admiral	093
Aiko	092
Akai	030
Aaron	179
Ambassador	177
Anam	180
Anam National	055
AOC	019, 030, 052, 185
Audiovox	092, 180, 451
Baysonic	180
Belcor	019
Bell & Howell	016, 154
Bradford	180
Brockwood	019
Brocksonic	236, 463
Candle	030, 056, 186
Carnivale	030
Carver	054
Celebrity	000
Cineral	092, 451
Citizen	030, 039, 056, 060, 092, 186, 280
Clairtone	185
Concerto	056
Contec	180, 185
Craig	180
Crosley	054
Crown	039, 180
Curtis Mathes	016, 030, 039, 047, 051, 054, 056, 060, 093, 145, 154, 166, 451
CXC	180
Daewoo	019, 039, 092, 451
Daytron	019
Denon	145
Dumont	017, 019
Electroband	000, 185
Emerson	019, 039, 154, 177, 178, 179, 180, 185, 236, 280, 282, 463
Envision	030
Fisher	154, 159
Fujitsu	179
Funai	171, 179, 180
Futuretech	180
GE	021, 047, 051, 055, 093, 135, 178, 282, 451
Gibraltar	017, 019, 030
GoldStar	019, 030, 056, 178
Gradiente	053, 056
Grunpy	179, 180
Hallmark	178
Harley Davidson	179
Harvard	180
Hitachi	056, 145, 151
Infinity	054
Inteq	017
JBL	054
JCB	000
JVC	053, 069, 160, 169
Kaypani	052
KEC	180
Kenwood	019, 030
KTV	030, 039, 180, 185, 280

LG	056
Logik	016
Luxman	056
LXI	047, 054, 154, 156, 178
Magnavox	020, 030, 054, 096, 179, 186, 187
Majestic	016
Marantz	030, 054
Matsushita	250
Megatron	145, 178
MEI	185
Memorex	016, 056, 150, 154, 178, 250
MGA	019, 030, 150, 178
Midland	017, 039, 047, 051, 135
Minutz	021
Mitsubishi	019, 093, 150, 178
Motorola	055, 093
MTC	019, 030, 056, 060, 185
Multitech	180
NAD	156, 166, 178
NEC	019, 030, 056
Nikko	030, 092, 178
Noshi	018
NTC	092
Onwa	180
Optimus	154, 166, 250
Optonica	093, 165
Orion	179, 236, 463
Panasonic	051, 055, 250
Penney	018, 019, 021, 030, 039, 047, 051, 056, 060, 135, 156, 178
Philco	019, 020, 030, 054, 096, 145, 463
Philips	054
Pilot	019, 030, 039
Pioneer	166
Portland	019, 039, 092
Prism	051
Proscan	047
Proton	052, 178
Pulsar	017, 019
Quasar	051, 055, 165, 250
Radio Shack	019, 030, 039, 047, 056, 154, 165, 178, 180
RCA	018, 019, 047, 051, 090, 093, 135
Realistic	019, 030, 039, 056, 154, 165, 178, 180
Rhapsody	185
Runco	017, 030
Sampo	030, 039, 052
Samsung	019, 030, 056, 060, 178
Samsux	039
Sansei	451
Sansui	463
Sanyo	154, 159
Scimitsu	019
Scotch	178
Scott	019, 178, 179, 180, 236
Sears	047, 054, 056, 154, 156, 159, 171, 178, 179
Semivox	180
Semp	156
Sharp	039, 093, 165
Shogun	019

Signature	016
mpson	186, 187
ony	000
oundesign	178, 179, 180, 186
quareview	171
SS	019, 180
arlite	180
upreme	000
ylvania	020, 030, 054, 096
ymphonic	171
andy	093
atung	055
chnics	051, 250
chnol Ace	179
chwood	051, 056
knika	016, 019, 039, 054, 056, 060, 092, 150, 179, 180, 186
elefunken	056
MK	056, 177, 178
shiba	060, 154, 156
sonic	185
television	039
ector Research	030
ctor	053
dikron	054
dtech	019, 178
ards	016, 019, 020, 021, 030, 054, 056, 096, 165, 178, 179
amaha	019, 030
enith	016, 017, 092

### Manufacturers' codes for DBS tuner

phaStar	772
chostar	775
xpressvu	775
tachi	819
TS	775
ghes Network Systems	749
errold	627
/C	775
anasonic	701
rimestar	627
CA	566
ony	639

### Manufacturers' codes for CATV converters

ABC	003, 007, 008, 011, 013, 014, 017
Allegro	153
Archer	153, 797
Century	153
Citizen	153
Comtronics	040
Contec	019
Emerson	797
Everquest	015, 040
Focus	400
Garrard	153
Gemini	015
General Instrument	011, 276, 476
GoldStar	040, 144
Goodmind	797
Hamlin	009, 020, 259, 273
Hitachi	011
Hytex	007
Jasco	153
Jerrold	003, 011, 012, 014, 015, 276, 476
Memorex	000
Novaplex	618
Oak	007, 019
Optimus	021
Panasonic	000, 021
Paragon	000
Philips	153
Pioneer	144, 533
Popular Mechanics	400
Prelude	770
Pulsar	000
Radio Shack	015, 797
RCA	021
Recoton	400
Regal	020, 259, 273
Rembrandt	011
Runco	000
Samsung	040, 144
Scientific Atlanta	008, 017, 277, 477
Signal	015, 040
Signature	011
SL Marx	040
Sprucer	021
Starcom	003, 015
Stargate	015, 040, 770, 797
Starquest	015
Televue	040
Tocom	012, 013
Toshiba	000
Tusa	015
Unika	153
United Artists	007
United Cable	003
Universal	153
Zenith	000
Zentek	400

## Manufacturers' codes for VCR

Admiral	048
Adventura	000
Aiko	278
Aiwa	000, 037
Akai	041, 053, 106
American High	035
Asha	240
Audiovox	037
Beaumark	240
Bell & Howell	104
Broksonic	002, 121, 184, 209, 211, 479
Calix	037
Canon	035
Capehart	020
Carver	081
CCE	072, 278
Cineral	278
Citizen	037, 278
Colt	072
Craig	037, 047, 072, 240, 271
Curtis Mathes	035, 041, 060, 162
Cybernex	240
Daewoo	020, 045, 278
Daytron	020
Denon	042
Dynatech	000
Electrohome	037
Electroponic	037
Emerex	032
Emerson	000, 002, 037, 043, 121, 184, 209, 211, 212, 278, 479
Fisher	047, 054, 104
Fuji	033, 035
Funai	000
Garrard	000
GE	035, 048, 060, 240
GoldStar	037, 038
Gradiente	000, 008
Harley Davidson	000
Harman/Kardon	038
Harwood	072
Headquarter	046
Hitachi	000, 041, 042
HI-Q	047
Jensen	041
JVC	008, 041, 067
KEC	037, 278
Kenwood	038, 041, 067
KLH	072
Kodak	035, 037
Lloyd's	000
Logik	072
LXI	037
Magnasonic	278

Magnavox	000, 035, 039, 081, 149
Magnin	240
Marantz	035, 081
Marta	037
Matsushita	035, 162
MEI	035
Memorex	000, 035, 037, 039, 046, 047, 048, 104, 162, 240
MGA	043, 240
MGN Technology	240
Minolta	042
Mitsubishi	043, 048, 067
Motorola	035, 048
MTC	000, 240
Multitech	000, 072
NEC	038, 041, 067, 104
Nikko	037
Nikon	034
Noblex	240
Olympus	035
Optimus	037, 048, 104, 162
Orion	002, 184, 479
Panasonic	035, 162, 225
Penney	035, 037, 038, 042, 054, 240
Pentax	042
Philco	035 209, 479
Philips	035, 081
Pilot	037
Pioneer	067, 162
Portland	020
Profitronic	240
Proscan	060
Protec	072
Pulsar	039
Quarter	046
Quartz	046
Quasar	035, 162
Radio Shack	000, 037
Radix	037
Randex	037
RCA	035, 042, 048, 060, 106, 149, 240
Realistic	000, 035, 037, 046, 047, 048, 104
Ricoh	034
Runco	039
Samsung	045, 053, 240
Sanky	039, 048
Sansui	000, 041, 067, 271, 479
Sanyo	046, 047, 104, 240
Scott	043, 045, 121, 184, 211, 212
Sears	000, 035, 037, 042, 046, 047, 054, 104
Semp	045
Sharp	048
Shintom	072
Shogun	240

Singer	072
Sony	000, 032, 033, 034, 035
STS	042
Sylvania	000, 035, 043, 081
Symphonic	000
Tatung	041
Teac	000, 041
Technics	035, 162
Teknika	000, 035, 037
Thomas	000
TMK	240
Toshiba	043, 045, 212
Totevision	037, 240
Unitech	240
Vector	045
Vector Research	038
Video Concepts	045
Videosonic	240
Wards	000, 035, 042, 047, 048, 060, 072, 081, 149, 212, 240
White Westinghouse	278
XR-1000	000, 035, 072
Yamaha	038
Zenith	000, 033, 034, 039

Manufacturers' codes listed on page 48 to 51 are subject to change without notice. If they are changed, this remote control cannot operate the equipment.

Use this chart to help you solve daily operational problems. If there is any problem you cannot solve, contact your DVD service center.

PROBLEM	POSSIBLE CAUSE	SOLUTION
The display does not light up.	The power cord is not plugged in.	Plug the power cord into an AC outlet.
No sound from speakers.	Speaker signal cables are not connected.	Check speaker wiring and reconnect if necessary.
	The SPEAKERS 1 and 2 buttons are not set correctly.	Press SPEAKERS 1 and 2 correctly.
	An incorrect source is selected.	Select the correct source.
	Muting is activated.	Press MUTING to cancel the mute.
Sound from one speaker only.	Speaker signal cables are not connected properly.	Check speaker wiring and reconnect if necessary.
	The balance is set to one extreme.	Adjust the balance properly (see page 12).
Continuous hiss or buzzing during FM reception.	Incoming signal is too weak.	Connect an outdoor FM antenna or contact your dealer.
	The station is too far away.	Select a new station.
	An incorrect antenna is used.	Check with your dealer to be sure you have the correct antenna.
	Antennas are not connected properly.	Check connections.
Occasional cracking noise during FM reception.	Ignition noise from automobiles.	Move the antenna farther from automobile traffic.
No colors on the on-screen display.	The color system of the connected TV is not NTSC.	Connect an NTSC TV.
Howling during record playing.	Your turntable is too close to speakers.	Move speakers away from the turntable.
“OVERLOAD” starts flashing on the display.	Speakers are overloaded because of high volume.	Rotate the MASTER VOLUME control counterclockwise three or four times, then press POWER on the front panel. If “OVERLOAD” does not disappear, unplug the AC power cord, then plug it back again.
	Speakers are overloaded because of short circuit of speaker terminals.	Press POWER on the front panel, then check the speaker wiring. If “OVERLOAD” does not disappear, unplug the AC power cord, then plug it back again. If speaker wiring is not short-circuited, contact your dealer.
Remote control does not work.	The remote control mode selector is not set correctly.	Set the selector correctly either to “AUDIO/TV/VCR” or to “CATV/DBS.”
	There is an obstruction in front of the remote sensor on the receiver.	Remove the obstruction.
	Batteries are weak.	Replace batteries.

## **Amplifier**

### Output Power

At Stereo operation:

Front channels: **120 watts per channel, min. RMS, driven into 8 ohms, 20 Hz to 20 kHz with no more than 0.02% total harmonic distortion.**

120 watts per channel, min. RMS, driven into 4 ohms, 20 Hz to 20 kHz with no more than 0.08% total harmonic distortion.

At Surround operation:

Front channels: 100 watts per channel, min. RMS, driven into 8 ohms at 1 kHz with no more than 0.8% total harmonic distortion.

Center channel: 100 watts, min. RMS, driven into 8 ohms at 1 kHz, with no more than 0.8% total harmonic distortion.

Rear channels: 100 watts per channel, min. RMS, driven into 8 ohms at 1 kHz, with no more than 0.8% total harmonic distortion.

## **Audio**

Audio Input Sensitivity/Impedance (1 kHz):	PHONO (MM):	2.5 mV/47 kohms
	CD, TAPE/MD, TV SOUND/DBS, VCR 1, VCR 2, VIDEO, DVD:	200 mV/47 kohms
Audio Input (DIGITAL IN)* :	Coaxial: DIGITAL 1 (DBS):	0.5 V <sub>p-p</sub> /75 ohms
	Optical: DIGITAL 2 (DVD), DIGITAL 3 (CD):	-21 dBm to -15 dBm (660 nm ±30 nm)
	* Corresponding to Linear PCM, Dolby Digital, and DTS Digital Surround (with sampling frequency — 32 kHz, 44.1 kHz, 48 kHz).	
Audio Output Level:	TAPE/MD, VCR 1, VCR 2:	200 mV
Signal-to-Noise Ratio ('66 IHF/'78 IHF):	PHONO:	70 dB/78 dB (at REC OUT)
	CD, TAPE/MD, TV SOUND/DBS, VCR 1, VCR 2, VIDEO, DVD:	87 dB/80 dB
Frequency Response (8 ohms):	PHONO:	20 Hz to 20 kHz (±1 dB)
	CD, TAPE/MD, TV SOUND/DBS, VCR 1, VCR 2, VIDEO, DVD:	20 Hz to 20 kHz (±1 dB)
RIAA Phono Equalization:	±1.0 dB (20 Hz to 20 kHz)	
Loudness Control (Volume Control at -30 dB):	+6 ±1.0 dB at 100 Hz +4 ±1.0 dB at 10 kHz	
	SEA: Center frequencies:	100 Hz, 1 kHz, 10 kHz
	Control range:	±10 dB ±2 dB

## **Video**

Video Input Sensitivity/Impedance:		
Composite video:	TV SOUND/DBS, VCR 1, VCR 2, VIDEO, DVD:	1 V <sub>p-p</sub> /75 ohms
S-video:	TV SOUND/DBS, VCR 1, VIDEO, DVD: (Y: luminance):	1 V <sub>p-p</sub> /75 ohms
	(C: chrominance, burst):	0.286 V <sub>p-p</sub> /75 ohms
Video Output Level:		
Composite video:	VCR 1, VCR 2, MONITOR OUT:	1 V <sub>p-p</sub> /75 ohms
S-video:	VCR 1, MONITOR OUT: (Y: luminance):	1 V <sub>p-p</sub> /75 ohms
	(C: chrominance, burst):	0.286 V <sub>p-p</sub> /75 ohms
Synchronization:	Negative	
Signal-to-Noise Ratio:	45 dB	
On-Screen Color System:	NTSC	

**FM tuner (IHF)**

Tuning Range:	87.5 MHz to 108.0 MHz	
Usable Sensitivity:	Monaural:	12.8 dBf (1.2 $\mu$ V/75 ohms)
50 dB Quieting Sensitivity:	Monaural:	21.3 dBf (3.2 $\mu$ V/75 ohms)
	Stereo:	41.3 dBf (31.5 $\mu$ V/75 ohms)
Signal-to-Noise Ratio (IHF-A weighted):	Monaural:	78 dB at 85 dBf
	Stereo:	73 dB at 85 dBf
Total Harmonic Distortion:	Monaural:	0.4% at 1 kHz
	Stereo:	0.6% at 1 kHz
Stereo Separation at REC OUT:	35 dB at 1 kHz	
Alternate Channel Selectivity:	45 dB: ( $\pm$ 400 kHz)	
Frequency Response:	30 Hz to 15 kHz: (+0.5 dB, -3 dB)	

**AM tuner**

Tuning Range:	530 kHz to 1,710 kHz	
Usable Sensitivity:	Loop antenna	400 $\mu$ V/m
Signal-to-Noise Ratio:	50 dB (100 mV/m)	

**General**

Power Requirements:	AC 120V $\sim$ , 60 Hz	
Power Consumption:	320 watts/420 VA (at operation)	
	2 watts (in standby mode)	
Dimensions (W x H x D):	435 x 157 x 412.5 mm	
	(17 <sup>3</sup> / <sub>16</sub> x 6 <sup>3</sup> / <sub>16</sub> x 16 <sup>1</sup> / <sub>4</sub> inches)	
Mass:	11.9 kg (26.3 lbs)	

Designs & specifications are subject to change without notice.



## HOW TO LOCATE YOUR JVC SERVICE CENTER

TOLL FREE : 1-800-537-5722

<http://www.jvcservice.com>

Dear customer:

In order to receive the most satisfaction from your purchase, read the instruction booklet before operating the unit. In the event that repair is necessary, or for the address nearest your location, please refer to the factory service center list below or within the Continental United States, Call 1-800-537-5722 for your authorized servicer. Remember to retain your Bill of Sale for Warranty Service.

—JVC

### JVC SERVICE & ENGINEERING COMPANY OF AMERICA

DIVISION OF JVC AMERICAS CORP.

#### FACTORY SERVICE CENTER LOCATIONS

107 Little Falls Road  
Fairfield, NJ 07004-2105  
(973) 808-9279

1500 Lakes Parkway  
Lawrenceville, GA 30243-5857  
(770) 339-2522

705 Enterprise Street  
Aurora, IL 60504-8149  
(630) 851-7855

5665 Corporate Avenue  
Cypress, CA 90630-0024  
(714) 229-8011

2969 Mapunapuna Place  
Honolulu, HI 96819-2040  
(808) 833-5828

10700 Hammerly, Suite 110  
Houston, TX 77043  
(713) 935-9331

13 Cummings Park  
Woburn, MA 01801  
(781) 376-9100

8192 State Road 84  
Davie, FL 33324  
(954) 472-1960

890 Dubuque Avenue  
South San Francisco, CA 94080-1804  
(650) 871-2666

*Sophisticated electronic products may require occasional service. Just as quality is a keyword in the engineering and production of the wide array of JVC products, service is the key to maintaining the high level of performance for which JVC is world famous. The JVC service and engineering organization stands behind our products.*

NATIONAL HEADQUARTERS  
JVC SERVICE & ENGINEERING COMPANY OF AMERICA  
DIVISION OF JVC AMERICAS CORP.  
1700 Valley Road  
Wayne, NJ 07470

#### ***If you ship the product •••***

*Pack your JVC unit in the original carton or one of equivalent size and strength. Enclose, with the unit, a letter stating the problem or symptom that exists and also a copy of the receipt or bill of sale you received when you purchased your JVC unit. Print your home return address on the outside and the inside of the carton. Send to the appropriate JVC Factory Service Center as listed above.*

#### **Don't service it yourself.**

##### **CAUTION**

*To prevent electrical shock, do not open the cabinet. No user serviceable parts inside.  
Refer servicing to qualified service personnel.*

#### **ACCESSORIES**

*To purchase accessories for your JVC product, you may contact your local JVC Dealer. Or from the 48 Continental United States call toll free : 800-882-2345*



# LIMITED WARRANTY AUDIO-2

JVC COMPANY OF AMERICA warrants this product and all parts thereof, except as set forth below ONLY TO THE ORIGINAL PURCHASER AT RETAIL to be FREE FROM DEFECTIVE MATERIAL AND WORKMANSHIP from the date of original retail purchase for the period as shown below. ("The Warranty Period.")

PARTS	LABOR
2YR	2YR

THIS LIMITED WARRANTY IS VALID ONLY IN THE FIFTY(50) UNITED STATES, THE DISTRICT OF COLUMBIA AND IN COMMONWEALTH OF PUERTO RICO.

**WHAT WE WILL DO:**

If this product is found to be defective, JVC will repair or replace defective parts at no charge to the original owner. Such repair and replacement services shall be rendered by JVC during normal business hours at JVC authorized service centers. Parts used for replacement are warranted only for the remainder of the Warranty Period. All products and parts thereof may be brought to a JVC authorized service center on a carry-in basis except for Television sets having a screen size 25 inches and above which are covered on an in-home basis.

**WHAT YOU MUST DO FOR WARRANTY SERVICE:**

Return your product to a JVC authorized service center with a copy of your bill of sale. For your nearest JVC authorized service center, please call toll free: (800)537-5722. If service is not available locally, box the product carefully, preferably in the original carton, and ship, insured, with a copy of your bill of sale plus and letter of explanation of the problem to the nearest JVC Factory Service Center, the name and location of which will be given to you by the toll-free number. If you have any questions concerning your JVC Product, please contact our Customer Relations Department.

**WHAT IS NOT COVERED:**

- This limited warranty provided by JVC does not cover:
1. Products which have been subject to abuse, accident, alteration, modification, tampering, negligence, misuse, faulty installation, lack of reasonable care, or if repaired or serviced by anyone other than a service facility authorized by JVC to render such service, or if affixed to any attachment not provided with the products, or if the model or serial number has been altered, tampered with, defaced or removed;
  2. Initial installation and installation and removal for repair;
  3. Operational adjustments covered in the Owner's Manual, normal maintenance, video and audio head cleaning;
  4. Damage that occurs in shipment, due to act of God, and cosmetic damage;
  5. Signal reception problems and failures due to line power surge;
  6. Video Pick-up Tubes/CCD Image Sensor, Cartridge, Stylus(Needle) are covered for 90 days from the date of purchase;
  7. Accessories;
  8. Batteries (except the Rechargeable Batteries are covered for 90 days from the date of purchase);

There are no express warranties except as listed above.

THE DURATION OF ANY IMPLIED WARRANTIES, INCLUDING THE IMPLIED WARRANTY OF MERCHANTABILITY, IS LIMITED TO THE DURATION OF THE EXPRESS WARRANTY HEREIN.

JVC SHALL NOT BE LIABLE FOR THE LOSS OF USE OF THE PRODUCT, INCONVENIENCE, LOSS OR ANY OTHER DAMAGES, WHETHER DIRECT, INCIDENTAL OR CONSEQUENTIAL (INCLUDING, WITHOUT LIMITATION, DAMAGE TO TAPES, RECORDS OR DISCS) RESULTING FROM THE USE OF THIS PRODUCT, OR ARISING OUT OF ANY BREACH OF THIS WARRANTY. ALL EXPRESS AND IMPLIED WARRANTIES, INCLUDING THE WARRANTIES OF MERCHANTABILITY AND FITNESS FOR PARTICULAR PURPOSE, ARE LIMITED TO THE WARRANTY PERIOD SET FORTH ABOVE.

Some states do not allow the exclusion of incidental or consequential damages or limitations on how long an implied warranty last, so these limitations or exclusions may not apply to you. This warranty gives you specific legal rights and you may also have other rights which vary from state to state.

JVC COMPANY OF AMERICA  
DIVISION OF JVC AMERICAS CORP.

1700 Valley Road  
Wayne, NJ 07470

REFURBISHED PRODUCTS CARRY A SEPARATE WARRANTY, THIS WARRANTY DOES NOT APPLY. FOR DETAILS OF REFURBISHED PRO DUCT WARRANTY, PLEASE REFER TO THE REFURBISHED PRODUCT WARRANTY INFORMATION PACKAGED WITH EACH REFURBISHED PRODUCT.

For customer use:

Enter below the Model No. and Serial No. which is located either on the rear, bottom or side of the cabinet. Retain this information for future reference.

Model No.: \_\_\_\_\_ Serial No.: \_\_\_\_\_

Purchase date: \_\_\_\_\_ Name of dealer: \_\_\_\_\_

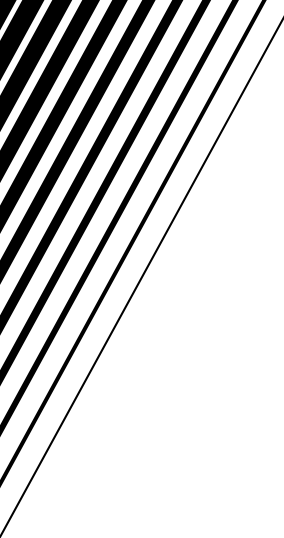

**JVC**  
VICTOR COMPANY OF JAPAN, LIMITED